

United States  
Department of  
Agriculture

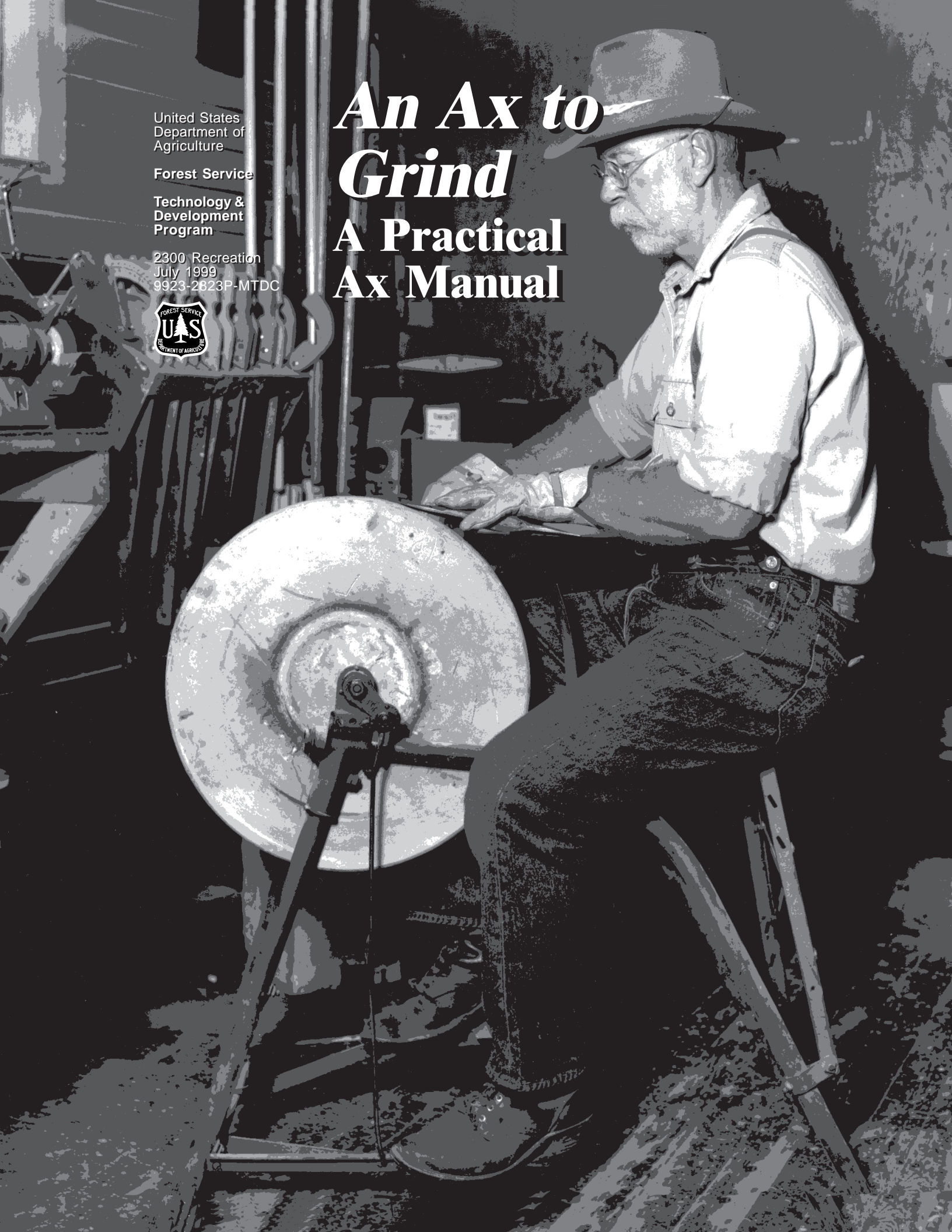
Forest Service

Technology &  
Development  
Program

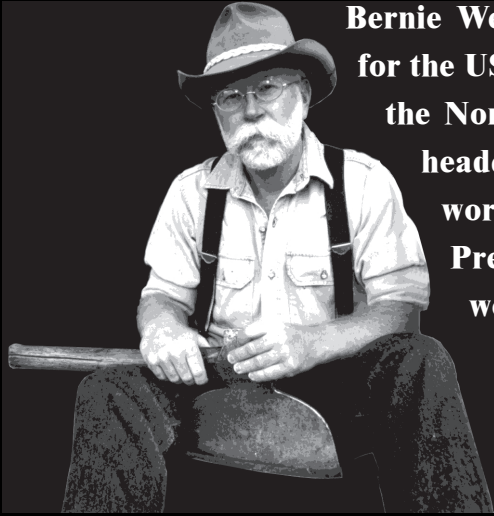
2300 Recreation  
July 1999  
9923-2623P-MTDC



# *An Ax to Grind* A Practical Ax Manual



## **A**bout the Author



**Bernie Weisgerber is a historic preservation specialist for the USDA Forest Service. He has been in charge of the Northern Region's Historic Preservation Team, headquartered in Missoula, MT, since 1991. He worked for the National Park Service's Historic Preservation Training Center before coming to work for the Forest Service.**

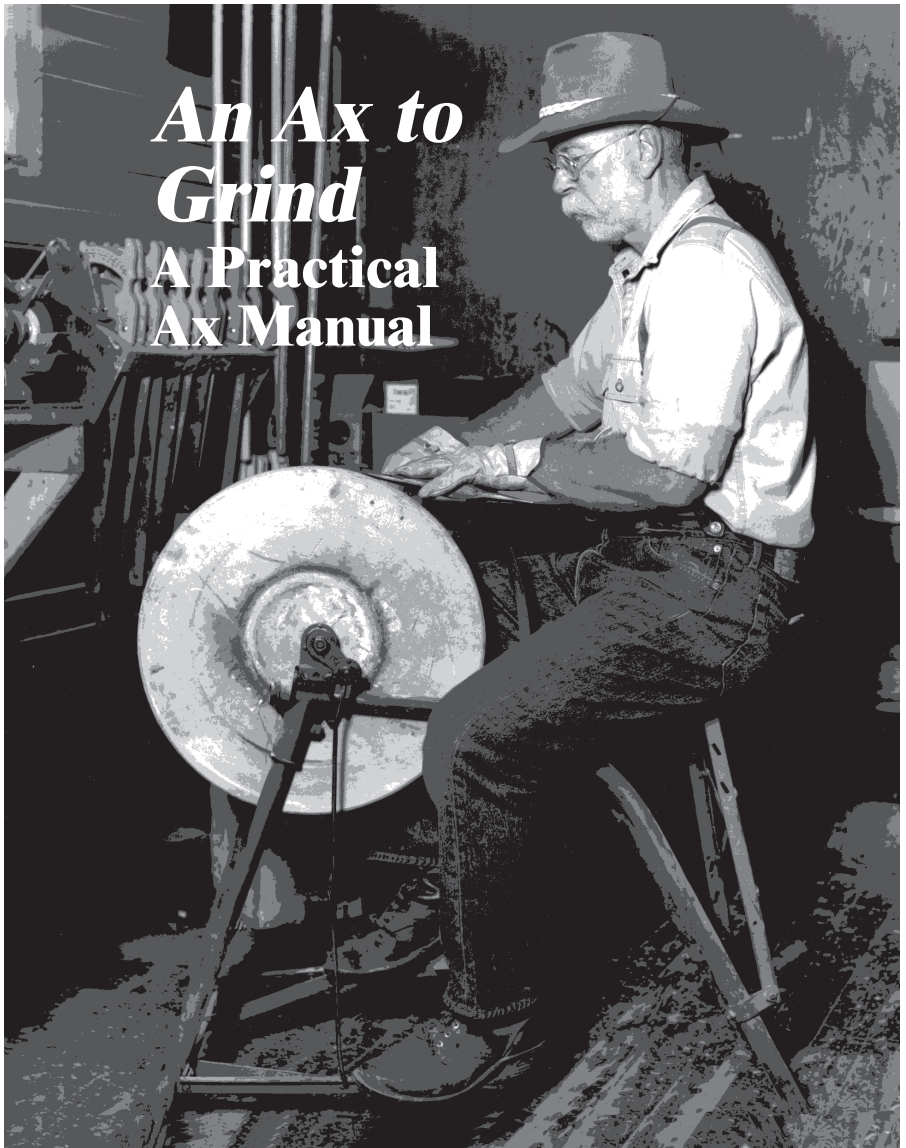
**Bernie and his crew of skilled craftsmen restore historic Federal buildings, often at remote sites, using traditional technologies and materials. The team's projects often provide training opportunities for other Federal employees and the general public, as part of the Forest Service's Passport in Time and Heritage Expeditions programs. Weisgerber has twice been a guest craftsman on National Public Broadcasting's *This Old House* television series.**



*My Favorite Ax*



**Passport in Time and Heritage Expeditions are part of the USDA Forest Service's Heritage Program that allows the public to explore the past on their national forests.**



# *An Ax to Grind* A Practical Ax Manual

**Bernie Weisgerber**  
*Author*

**Brian Vachowski**  
*Project Leader*

**USDA Forest Service**  
**Technology and Development Program**  
**Missoula, MT**

**SE82A42—Ax Manual/Video for Heritage**  
**Site Restoration**

**July 1999**

The Forest Service, United States Department of Agriculture, has developed this information for the guidance of its employees, its contractors, and its cooperating Federal and State agencies, and is not responsible for the interpretation or use of this information by anyone except its own employees. The use of trade, firm, or corporation names in this publication is for the information and convenience of the reader, and does not constitute an endorsement by the Department of any product or service to the exclusion of others that may be suitable. The United States Department of Agriculture (USDA) prohibits discrimination in all its programs and activities on the basis of race, color, national origin, sex, religion, age, disability, political beliefs, sexual orientation, or marital or family status. (Not all prohibited bases apply to all programs.) Persons with disabilities who require alternative means for communication of program information (Braille, large print, audiotape, etc.) should contact USDA's TARGET Center at (202) 720-2600 (voice and TDD). To file a complaint of discrimination, write: USDA, Director, Office of Civil Rights, Room 326-W, Whitten Building, 1400 Independence Avenue SW, Washington, D.C. 20250-9410, or call (202) 720-5964 (voice and TDD). USDA is an equal opportunity provider and employer.

# Table of Contents



<b>Acknowledgments</b>	<b>v</b>
<b>Brief History of the Ax</b>	<b>1</b>
Evolution of the Ax in America	1
Ax Types, Patterns, and Uses	4
American Felling Ax	7
Double-Bit Ax	8
Broad Ax	9
Other Axes and Hatchets	10
Adzes	13
Decline of the American Ax	14
<b>Getting the Hang of It</b>	<b>17</b>
Basics of Handle Selection	19
Hanging Procedure	21
Sharpening	27
<b>Using Axes</b>	<b>33</b>
A Most Versatile Tool	33
Using an Ax Safely	33
Chopping Technique	35
Felling Trees	38
Limbing	41
Cutting Pinned-Down Saplings	42
Bucking	42
Splitting	44
Hewing	45
<b>Buying an Ax</b>	<b>51</b>
New and Used Axes	51
Manufacturers	51
Distributors	53
Organizations	55
<b>Selected References</b>	<b>57</b>



# Acknowledgments

**F**rom the time this manuscript began as a series of audio tapes, *An Ax to Grind: A Practical Ax Manual* has benefited from a lot of assistance. I would like to thank the following Missoula Technology and Development Center staff and other Forest Service employees for their major contributions.

**John Alley (Northern Region)**

**Bob Beckley**

**Michelle Beneitone**

**Ted J. Cote**

**Gary Hoshide**

**Jim Kautz**

**Bert Lindler**

**David Michael (Apache-Sitgreaves National Forest)**

**Brian Vachowski**

**Gloria Weisgerber (Northern Region)**

**Mark Wiggins**

**Jerry Taylor Wolf**

**Printing**

**Photography**

**Text processing**

**Design and layout**

**Review**

**Photography**

**Editing**

**Review**

**Project Leader,  
research, writing,  
editing**

**Review**

**Photography**

**Research, editing**

I would also invite you to look at the companion video program, *An Ax to Grind*. Parts 1 and 2 of the program are each 30 minutes long. Copies are available from MTDC at the address on the inside of the back cover.

Many of the photographs are of axes from Bernie Weisgerber's personal collection. Many of the illustrations were drawn by Frederic H. Kock for Bernard S. Mason's book, *Woodsmanship* (1954). The illustrations are used here by permission of Mrs. Frederic H. Kock.





## Brief History of the Ax

I've always had a passion for axes. I received my first ax—a toy—when I was 8 years old, and my first real ax not long afterwards. Since that time, for over 45 years, I've used and collected all kinds of axes and adzes in my professional work restoring historic buildings and structures.

We cannot explore everything there is to know about axes in this publication. What I would like to share with you is a brief background on the development of axes, the hanging and sharpening of axes, how to use an ax, and detailed information on certain ax patterns. I've tried to place the discussion within the context of working with axes today and from a historical perspective of their use within the USDA Forest Service.

In *An Ax to Grind: A Practical Ax Manual*, you'll find:

- A brief look at the history of the ax, especially its evolution in America
- Types and patterns of axes and adzes, showcasing some examples from my personal collection and some from old catalogs
- How to hang and sharpen an ax, two essential skills for anyone using an ax
- Various examples of using axes, incorporating historical material
- Where to buy a good ax
- Some other good references about axes that you may find useful.

This manual is intended to be a companion to my video program, *An Ax to Grind* (99-01-MTDC). The video (Figure 1) was produced by the Missoula Technology and Development Center (MTDC). Copies are available from the center. I hope you'll take a look at it.



Figure 1—The video program, *An Ax to Grind* (99-01-MTDC), is a companion to this manual. The video is available from Missoula Technology and Development Center.

## Evolution of the Ax in America

**...having an ax to grind**  
Getting even for a perceived wrongdoing.

**...barking your knuckles**  
Scraping your knuckles on the side of a log while hewing it.

**...can't get the hang of it**  
Can't get it right, originally referring to the way an ax handle was mounted to the ax head.



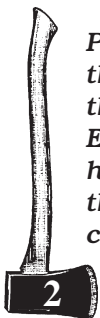
Although we still make references to axes in our daily speech, most Americans have a limited knowledge about them (Figure 2), including how to use and properly maintain them. But the ax, in one form or another, has been around for over 10,000 years—even longer if you consider some of the crude stone tools used as axes by early man.



Figure 2—Barking your knuckles comes with the territory when you choose to hew logs with a broad ax.

While the ax has gone through transformations from stone, copper, bronze, and iron to steel, its overall shape and function have remained consistent (Figure 3). The ax was the first real woodworking tool, one of only a few available for a long period. For centuries the ax was one of mankind's most useful tools.

The early iron and steel axes used in America had European roots. Henry J. Kauffman, in his introduction to *American Axes* (1994), wrote:



*Part of the problem of focusing attention on the American axe arises from the fact that the earliest ones used here were made in Europe, and certainly the first ones made here were European in character. Thus, in the earliest colonial times a dividing line could not be drawn between the two catego-*

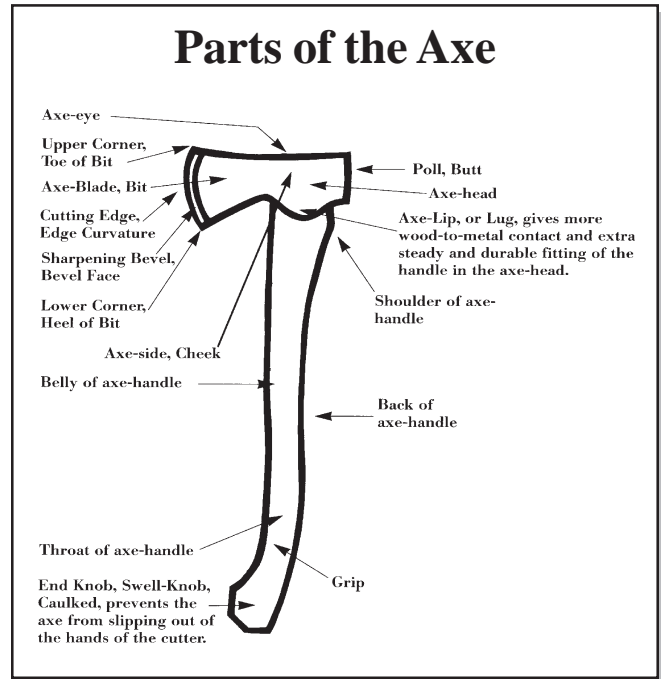


Figure 3—Parts of the ax. (Courtesy of Gränsfors Bruks AB, Sweden.)

*ries. As a matter of fact, the object was really a European-American axe. Because iron, unlike wood, is similar regardless of the place it was made, the essential substance of an axe does not help to identify its origin. Short of some identifiable maker's mark, the manufacturers of most of our early axes must remain anonymous.*

*It seems certain that most of the first axes made in North America were made and used on the Atlantic seaboard, a few exceptions occurring when trading companies brought in blacksmiths to their centers of exchange to repair and resharpen axes. As settlers moved westward and southward, their needs were supplied by smiths who went with them and were responsive to individual needs. This procedure was the beginning of very high specialization in the forms of axes, a differentiation which was picked up by the big manufacturers in the nineteenth century. The axes were mostly of the felling variety, but there were other purposes for which an axe was needed.*



*The pace of specialization increased; as evidence of this trend, one manufacturer informed the writer that at one time the company manufactured about three hundred different types. The president of the Mann Edge Tool Company, in Lewistown, Pennsylvania, reported that in 1969 they were producing seventy different patterns; however, the bulk of their production involved only about twenty.*

The ax became quite specialized in Europe during the Middle Ages and afterward. When European colonists dispersed throughout the New World, they brought their tools and their knowledge with them. It is not surprising to see the appearance of trade axes (Figures 4 and 5) and Germanic goose-wing hewing axes. We also see examples of older European-style specialized axes (Figures 6, 7, and 8) in America.



Figure 4—A 17th-century trade ax, typically made in northern Spain and traded by the French with American Indians.

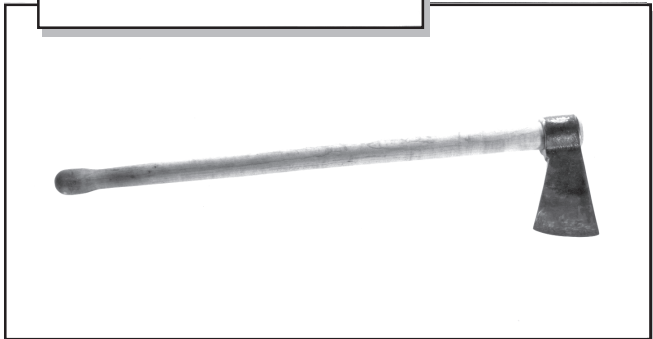


Figure 5—An early 20th-century Collins ax manufactured for the South American market. Note the similarity in design of the two axes.

Figure 6—An 18th-century mortising ax or twibil gives an idea of the specialization apparent even in early axes. Length, 4 feet.

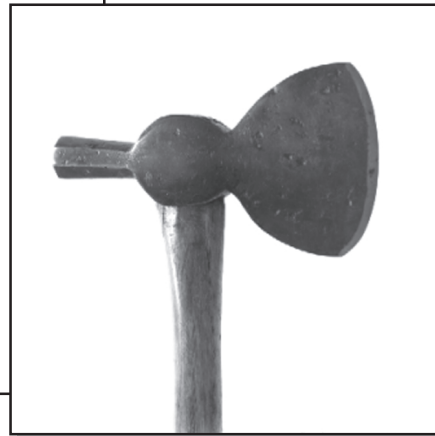
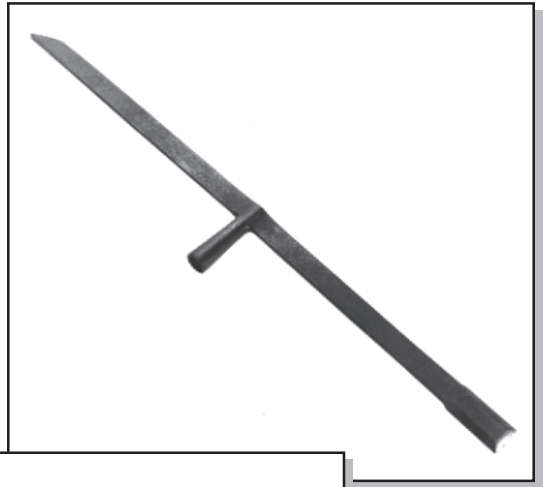
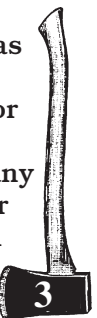


Figure 7—An 18th-century shingling hatchet is another specialized ax. Ax head is 5½ inches long by 4 inches wide.



Figure 8—An 18th-century splitting ax, with straight handle typical of early axes.

Americans modified European axes for two principal reasons (Kauffman 1994). First, the European axes were not as well suited to the virgin stands of huge trees found in America as they were for the smaller timber stands of Europe. The European axes were good tools for hewing, but less adequate for felling. The second reason, Kauffman suggests, is that many of the Europeans who left their homelands for an uncertain future in America were prepared



to adapt to survive. Their pioneering spirit bred ingenuity.

The need for a better felling ax, the need to process huge amounts of timber during America's settlement, and American ingenuity made development of the American felling ax inevitable.

We no sooner got started on this book than confusion over terminology set in. The simplest term to decide was "ax" instead of "axe." Although most historical sources go with axe, we chose ax because that spelling is preferred in the Government's style manual. More problematic was the correct term for a single-bit ax. We found single-bit axes described as a single-bit ax, felling ax, American ax, and pole ax. Although woods workers commonly refer to a single-bit ax as a pole ax, dictionaries refer to the pole ax as a medieval battle ax, an ax that's quite a bit different than the axes we are writing about. Pole ax probably refers to the poll (steel counterweight) on the back of the head of a modern single-bit ax. The trade axes that preceded the single-bit ax did not have a poll. The American ax and felling ax have slightly different meanings to me, so we compromised on single-bit ax throughout most of the text. Whether or not single-bit axes should be hyphenated is yet another story. We chose to rely on a modern dictionary for the spelling.

## Ax Types, Patterns, and Uses

During the 19th century, America's agrarian society was not as mobile as our society is today. People lived their lives in relatively small geographic areas. This is one explanation of the hundreds of different ax-head patterns that developed over the last 150 years.

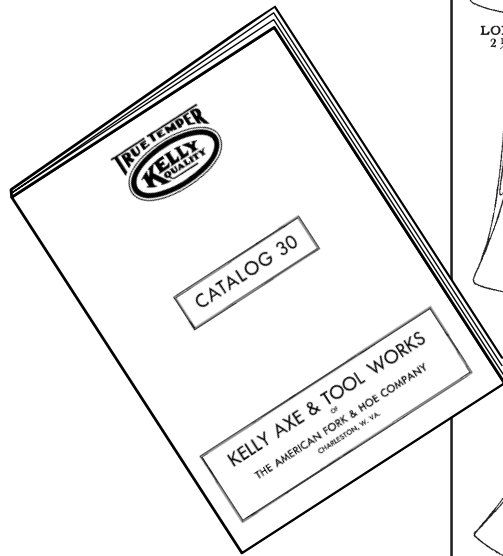
The individual skills of local blacksmiths and their view of what an ax needed were important factors in the development of ax-head patterns. Ax patterns became a matter of regional preference.


Around the turn of the 19th century, more than 300 different ax-head patterns were being manufactured in the United States. Many were nearly identical. To simplify identification and eliminate unnecessary or duplicate patterns, the Ax Manufacturers' Association agreed to set a standard, which resulted in a standard chart of ax patterns (Figure 9).

Certain ax patterns become popular within a given geographic area, such as the Jersey (my particular favorite), the Michigan, the Dayton, and the Kentucky (Figure 10). At times, ax head patterns included a name that related to their use. For example, the rafting ax pattern originated in the day when logs were rafted down rivers.

Ax-head patterns were also adapted to the timber that was available in the local area. The double-bit ax was originally developed in Pennsylvania (Figure 11). But the double-bit axes with a long, narrow, heavy ax head and a long handle, were developed for cutting large trees in the Pacific Northwest. Some of the patterns from this area were the Puget Sound, the Young's felling pattern, the Redwood pattern, and the Humboldt pattern.





**KELLY AXE & TOOL WORKS**  **CHARLESTON, W. VA.**

**STANDARD PATTERNS**  
Single and Double Bit Axes

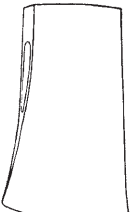
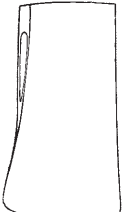
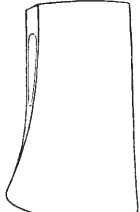

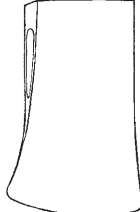

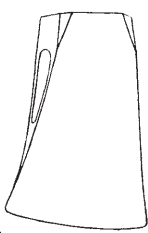
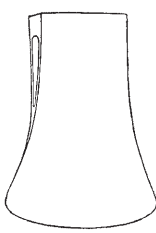
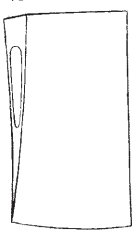
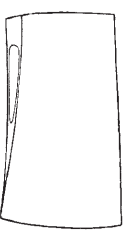
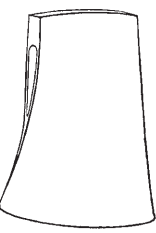


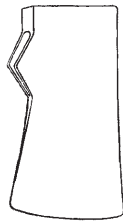


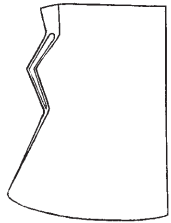
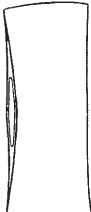
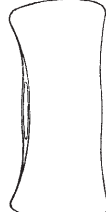




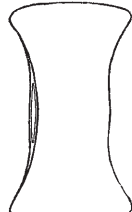

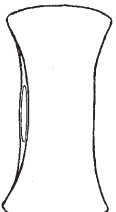


 <b>LONG ISLAND</b> 2½ to 3½ lbs.	 <b>NARROW WISCONSIN</b> 3 to 5 lbs.	 <b>NEW ENGLAND or IMPROVED WISCONSIN</b> 2½ to 6 lbs.	 <b>YANKEE</b> 3 to 8 lbs.	 <b>DELAWARE or WIDE BIT DAYTON</b> 3 to 5 lbs.	 <b>DAYTON</b> 3 to 8 lbs.
 <b>RAFTING</b> 5 lbs.	 <b>HOOSIER</b> 3 to 5 lbs.	 <b>WEDGE</b> 3 to 5 lbs.	 <b>HALF WEDGE</b> 3 to 5 lbs.	 <b>CONNECTICUT</b> 2½ to 5 lbs.	 <b>MICHIGAN</b> 3 to 8 lbs.
 <b>ROCKAWAY</b> 3 to 6 lbs.	 <b>NORTH CAROLINA</b> 3 to 7 lbs.	 <b>KENTUCKY</b> 3 to 7 lbs.	 <b>BALTIMORE KENTUCKY</b> 3 to 7 lbs.	 <b>JERSEY</b> 2½ to 6 lbs.	
 <b>WEDGE</b> 3 to 4 lbs.	 <b>WISCONSIN</b> 3 to 5 lbs.	 <b>NARROW MICHIGAN</b> 3 to 4 lbs.	 <b>MICHIGAN</b> 2½ to 7 lbs.	 <b>WESTERN or PENNSYLVANIA</b> 3 to 7 lbs.	
 <b>REVERSIBLE or HALF PEELING</b> 3 to 6 lbs.	 <b>FULL PEELING</b> 3 to 5 lbs.	 <b>REDWOOD or HUMBOLDT</b> 3 to 5 lbs.	 <b>YOUNG</b> 3 to 5 lbs.	 <b>SWAMPING</b> 3 to 5 lbs.	 <b>PUGET SOUND FALLING</b> 3 to 5 lbs.

Figure 9—Some standard patterns manufactured by True Temper Kelly in 1925.



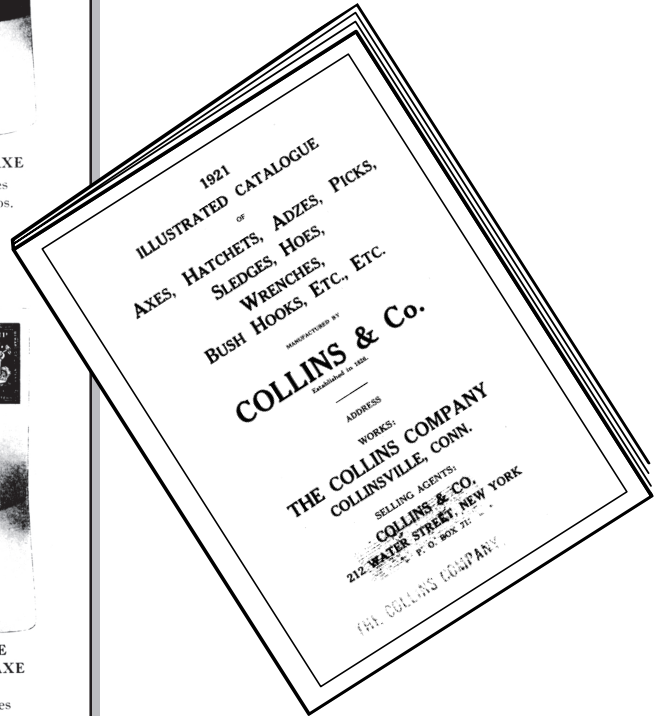


Figure 10—Some Collins Company “American axes” from the company’s 1921 catalog.



Figure 11—A 19th-century “Hand Made” double-bit ax.

## American Felling Ax

During the period in which the trade ax was being introduced to the North American Indians, the felling ax was brought to America by settlers from England, France, and Spain.

The 17th-century felling ax was made of two pieces of iron that were hammer welded down the center of the poll surface. Later axes had a thin poll with a flat surface. When North American blacksmiths began making the felling axes, they forged the poll side of the pattern longer in order to make a lap weld, which gave more welding surface. This produced a heavier poll with more weight behind the handle, providing better balance. In essence, this design is the modern ax that we use today (Kauffman 1994) (Figure 12).



Figure 12—Winchester ax and hatchet, Michigan pattern, typical of the American felling ax.

An edge tool maker's advertisement in the *Pennsylvania Packet and Daily Advertiser* on July 7, 1789, shows that the American felling ax was fully developed then. The illustration closely resembles the Kentucky pattern made by the Douglas Ax Company and illustrated in its 1863 catalog. The Jersey pattern, my personal favorite, is very similar to the model of 1789. It is still available. In the mid-19th century, some of the American axes were still made of both iron and steel. An iron poll and a

high-carbon-steel single-bit ax appears in an advertisement in the October 29, 1859, issue of *Scientific American* (Kauffman 1994).

The addition of the poll by an unknown North American blacksmith is what makes the American felling ax unique. Late 18th-century iron axes often had steel insert cutting edges. Earlier European axes with their long blades were awkward to use. When North Americans ground down the blades after sharpening them many times, they discovered that they could use them to cut more accurately. These axes had better balance and geometry. The blade wobbled less during the swing. After this discovery, American axes were made with shorter, wider blades.

In the late 18th century, some axes became almost square. These axes are often referred to as the American ax (Figure 13). Introduction of



Figure 13—My favorite American felling ax, a True Temper Kelly Perfect with a Jersey head and 32-inch straight hickory handle.





the Bessemer process for making steel in the late 19th century made steel affordable. The entire ax blade could be made of steel. Polished steel axes reduce the friction between the blade and the log. The ax blade can be made even thinner, allowing size and weight to be reduced while maintaining cutting efficiency. Making the entire ax wider with a heavier poll gave it more balance than the narrow, long-bladed English or European ax with little or no poll (Kauffman 1994).

The head of a full-size single-bit ax or poll ax weighed 3 to 6 pounds. The handle was 30 to 36 inches long.

The single-bit felling ax, or American ax, became the international standard for quality axes.

The double-bit ax weighed from about 2½ to 5 pounds and had a handle that was 26 to 42 inches long (Figure 15).

## Double-Bit Ax

The first double-bit ax was probably made by William Mann in Pennsylvania at about 1850. The Mann Edge Tool Company is one of the few American companies still in the business of making axes. By 1860 the double-bit ax was very common in the Northeast. The double-bit was not widely popular until the last quarter of the 19th century when it came into its own in the Pacific Northwest (Figure 14).

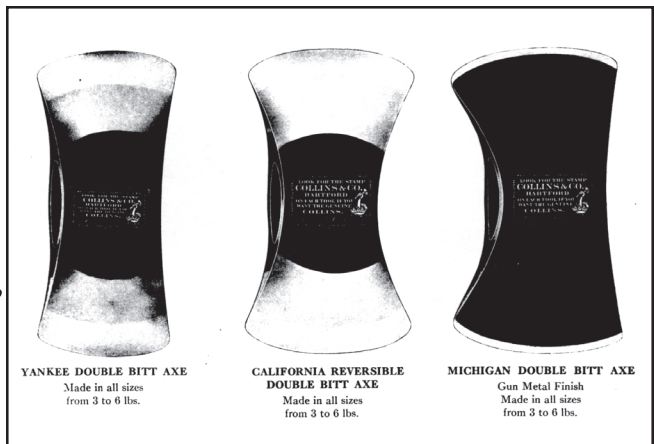


Figure 14—Three double-bit patterns available from Collins in 1921.



Figure 15—Three representative double-bit patterns: Bluegrass Western pattern double-bit ax (top); True Temper Kelly Perfect Michigan pattern double-bit ax (middle); and a 2½-pound reversible cruiser ax, sometimes used for ax throwing (bottom).



Which is better, a single-bit or double-bit ax? No other question is likely to raise as much controversy among ax enthusiasts as this one. Although the single-bit or poll ax was developed first and has remained popular, the double-bit developed a strong following because of its balanced feel and versatility. Typically, one blade was sharpened to a finely honed, narrow “felling edge,” while the second blade was ground slightly blunter, and used for knots, cutting near the ground, or in other instances where a finely sharpened blade was more likely to be damaged.

The double-bit ax remains a popular utility ax in the Western United States, especially among agencies like the USDA Forest Service. The single-bit ax also remains popular. All of the competition axes are single-bit axes. In my opinion, a single-bit ax is a more efficient cutting tool; the double-bit is more versatile.

## Broad Ax

Other special-purpose axes helped develop America. The hewing ax (also called broad ax or side ax) was used to square timber or flatten the sides of logs. It was used primarily for log buildings and timber framing, either in house or barn construction. Hewn timber was also used for railroad ties and trestle bridges.

The goose-wing broad axes (Figure 16) brought to America by German settlers were the earliest hewing axes commonly used in this country.



Figure 16—An 18th-century Germanic goose-wing hewing ax. There are maker’s marks hammered into the blade.

These axes were first used in Bucks County, PA. An earlier pattern of hewing ax known as the medieval goose-wing ax occasionally shows up (Figure 17). Goose-wing broad axes were made in both left- and right-handed models. The goose-wing handle was offset to the left or right by fitting it into a bent metal tube forged to the bit. Later hewing axes, known as American broad axes, had a handle that allowed the head to be taken off and re-versed for use by right-handers or left-handers.

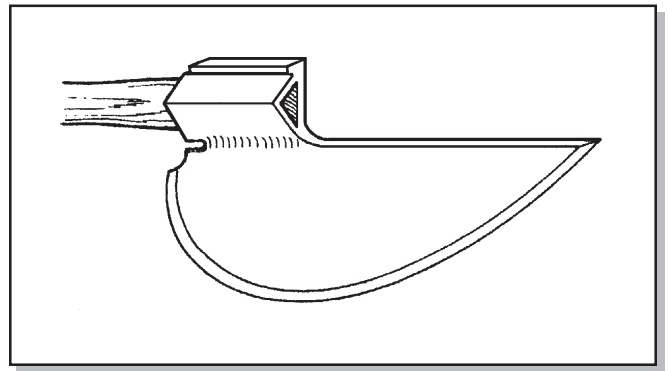


Figure 17—A medieval goose-wing ax that differs from the Germanic goose-wing axes brought into the United States by early settlers.

American broad ax patterns had geographic names. The most popular were the Pennsylvania, Western, Canadian, and, the New Orleans pattern, my favorite (Figures 18a, b, c, d, and e). Until the 1930’s the Western and Canadian patterns were used to hack railroad ties. The slang expression for a person who made railroad ties was a “tie hacker.”

The hewing ax is the preferred tool for flattening the surface of round logs. In past centuries, wood beams were often made by splitting the logs with some type of mallet and wedge, or glut. Then they were surfaced with an adz or a hewing ax. When iron axes became available, the hewing ax almost replaced the adz. Hewing axes were frequently used to roughly square the logs before they were sawn into boards with a pit saw.

Even after the sawmill became common, the hewing ax was still used for hewing beams and planks in the Northwest. It was often easier to



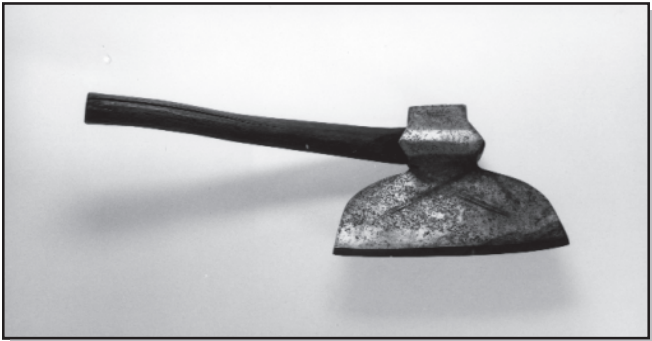


Figure 18a—Beatty Pennsylvania broad ax.



Figure 18b—Early 20th-century Douglas, New Orleans broad ax—my favorite.



Figure 18c—Early 20th-century Beatty knife-edge tie hacker's broad ax.

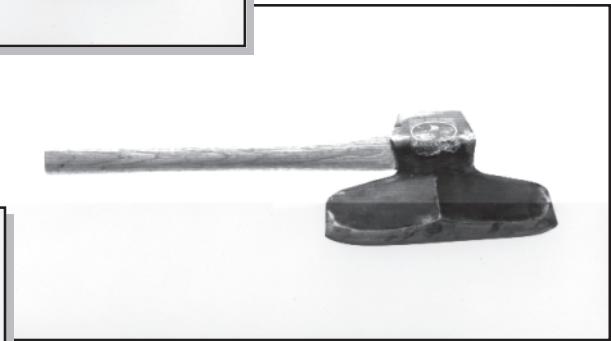


Figure 18d—Kelly 20th-century Canadian broad ax.



Figure 18e—A 19th-century shipwright's mast broad ax.

fell the tree, hew it square into cants, and skid the cants to the building site rather than to load and transport round logs to the sawmill where they would be sawn before being brought back to the building site. The hewing ax has been used in the same manner for about 2,000 years.



## Other Axes and Hatchets

Axes have other uses besides felling timber and building houses. Splitting axes are used for splitting firewood or rails. Hatchets, with their short heads and handles, are used in the building trades, and for camping and hunting (Figure 19). Some axes and hatchets are used specifically for mortising (Figure 20), wood carving, flooring, shingling, and carpentry (Figures 21a and 21b). Special competition axes are also used in logging contests where people chop while racing the clock and each other (Figure 22).







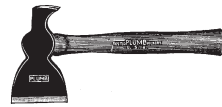









Figure 19—Plumb 2½-lb boy's ax with 19-inch handle—my favorite for log cabin work.

Figure 20—An 18th-century mortising ax.

## PLUMB HATCHETS

Advertised Finish—Smooth Black Head and tested Red Handle with PERMABOND Handle Assembly  
 PERMABOND is a Revolutionary New Chemical Weld that Binds Head to Handle Permanently  
 Electrically controlled furnaces assure you of a cutting edge that stays sharp. Plumb Handles are turned from tough, springy hickory that must pass rigid strength tests before being used.

<p><b>"AUTOGRAF" HALF HATCHET</b></p>  <p>Polished Finish Head Flat-Sided Red Handle</p> <table border="0"> <tr> <th>No.</th> <th>Bit Length</th> <th>Hdle. Length</th> <th>Weight Per Doz.</th> </tr> <tr> <td>AH2</td> <td>3½"</td> <td>13½"</td> <td>23 lbs.</td> </tr> </table>	No.	Bit Length	Hdle. Length	Weight Per Doz.	AH2	3½"	13½"	23 lbs.	<p><b>PLUMB HALF HATCHETS</b></p>  <p>Advertised Finish</p> <table border="0"> <tr> <th>No.</th> <th>Bit Length</th> <th>Hdle. Length</th> <th>Weight Per Doz.</th> </tr> <tr> <td>2961</td> <td>3¼"</td> <td>13"</td> <td>20 lbs.</td> </tr> <tr> <td>2962</td> <td>3½"</td> <td>13½"</td> <td>26 lbs.</td> </tr> </table> <p>Checked Milled Face CH2962 ..... 3½" 13½" 26 lbs.</p>	No.	Bit Length	Hdle. Length	Weight Per Doz.	2961	3¼"	13"	20 lbs.	2962	3½"	13½"	26 lbs.	<p><b>PLUMB HALF HATCHET</b></p>  <p>Polished Finish Head Red Handle</p> <table border="0"> <tr> <th>No.</th> <th>Bit Length</th> <th>Hdle. Length</th> <th>Weight Per Doz.</th> </tr> <tr> <td>530</td> <td>3½"</td> <td>13"</td> <td>20 lbs.</td> </tr> </table>	No.	Bit Length	Hdle. Length	Weight Per Doz.	530	3½"	13"	20 lbs.
No.	Bit Length	Hdle. Length	Weight Per Doz.																											
AH2	3½"	13½"	23 lbs.																											
No.	Bit Length	Hdle. Length	Weight Per Doz.																											
2961	3¼"	13"	20 lbs.																											
2962	3½"	13½"	26 lbs.																											
No.	Bit Length	Hdle. Length	Weight Per Doz.																											
530	3½"	13"	20 lbs.																											
<p><b>PLUMB BROAD HATCHETS</b></p>  <p>Advertised Finish</p> <table border="0"> <tr> <th>No.</th> <th>Bit Length</th> <th>Hdle. Length</th> <th>Weight Per Doz.</th> </tr> <tr> <td>2991</td> <td>4"</td> <td>13¾"</td> <td>25 lbs.</td> </tr> <tr> <td>2992</td> <td>4½"</td> <td>14½"</td> <td>30 lbs.</td> </tr> </table>	No.	Bit Length	Hdle. Length	Weight Per Doz.	2991	4"	13¾"	25 lbs.	2992	4½"	14½"	30 lbs.	<p><b>PLUMB CLAW HATCHET</b></p>  <p>Advertised Finish</p> <table border="0"> <tr> <th>No.</th> <th>Bit Length</th> <th>Hdle. Length</th> <th>Weight Per Doz.</th> </tr> <tr> <td>2972</td> <td>4"</td> <td>14"</td> <td>29 lbs.</td> </tr> </table>	No.	Bit Length	Hdle. Length	Weight Per Doz.	2972	4"	14"	29 lbs.	<p><b>PLUMB FLOORING HATCHET</b></p>  <p>Advertised Finish</p> <table border="0"> <tr> <th>No.</th> <th>Bit Length</th> <th>Hdle. Length</th> <th>Weight Per Doz.</th> </tr> <tr> <td>2985</td> <td>3¾"</td> <td>13½"</td> <td>25 lbs.</td> </tr> </table>	No.	Bit Length	Hdle. Length	Weight Per Doz.	2985	3¾"	13½"	25 lbs.
No.	Bit Length	Hdle. Length	Weight Per Doz.																											
2991	4"	13¾"	25 lbs.																											
2992	4½"	14½"	30 lbs.																											
No.	Bit Length	Hdle. Length	Weight Per Doz.																											
2972	4"	14"	29 lbs.																											
No.	Bit Length	Hdle. Length	Weight Per Doz.																											
2985	3¾"	13½"	25 lbs.																											
<p><b>PLUMB CAR BUILDERS' HATCHETS</b></p>  <p>Advertised Finish</p> <table border="0"> <tr> <th>No.</th> <th>Bit Length</th> <th>Hdle. Length</th> <th>Weight Per Doz.</th> </tr> <tr> <td>CB2</td> <td>3½"</td> <td>13½"</td> <td>28 lbs.</td> </tr> </table> <p>Checked Head CBX2 ..... 3½" 13½" 28 lbs.</p>	No.	Bit Length	Hdle. Length	Weight Per Doz.	CB2	3½"	13½"	28 lbs.	<p><b>RIGSTER HATCHET</b></p>  <p>Advertised Finish</p> <table border="0"> <tr> <th>No.</th> <th>Bit Length</th> <th>Hdle. Length</th> <th>Weight Per Doz.</th> </tr> <tr> <td>RB2</td> <td>3½"</td> <td>18"</td> <td>30 lbs.</td> </tr> </table>	No.	Bit Length	Hdle. Length	Weight Per Doz.	RB2	3½"	18"	30 lbs.	<p><b>PLUMB LATH HATCHET</b></p>  <p>Advertised Finish</p> <table border="0"> <tr> <th>No.</th> <th>Bit Length</th> <th>Hdle. Length</th> <th>Weight Per Doz.</th> </tr> <tr> <td>2981</td> <td>2¼"</td> <td>12½"</td> <td>18 lbs.</td> </tr> </table>	No.	Bit Length	Hdle. Length	Weight Per Doz.	2981	2¼"	12½"	18 lbs.				
No.	Bit Length	Hdle. Length	Weight Per Doz.																											
CB2	3½"	13½"	28 lbs.																											
No.	Bit Length	Hdle. Length	Weight Per Doz.																											
RB2	3½"	18"	30 lbs.																											
No.	Bit Length	Hdle. Length	Weight Per Doz.																											
2981	2¼"	12½"	18 lbs.																											
<p><b>PLUMB BARREL HATCHET</b></p>  <p>Advertised Finish</p> <table border="0"> <tr> <th>No.</th> <th>Bit Length</th> <th>Hdle. Length</th> <th>Weight Per Doz.</th> </tr> <tr> <td>535</td> <td>2¾"</td> <td>12"</td> <td>17 lbs.</td> </tr> </table>	No.	Bit Length	Hdle. Length	Weight Per Doz.	535	2¾"	12"	17 lbs.	<p><b>PLUMB PRODUCE HATCHET</b></p>  <p>Advertised Finish</p> <table border="0"> <tr> <th>No.</th> <th>Bit Length</th> <th>Hdle. Length</th> <th>Weight Per Doz.</th> </tr> <tr> <td>3005</td> <td>2½"</td> <td>12"</td> <td>15 lbs.</td> </tr> </table>	No.	Bit Length	Hdle. Length	Weight Per Doz.	3005	2½"	12"	15 lbs.	<p><b>SERVALL HALF HATCHET</b></p>  <p>Rough Black Finish Ivory Lacquered Handle</p> <table border="0"> <tr> <th>No.</th> <th>Bit Length</th> <th>Hdle. Length</th> <th>Weight Per Doz.</th> </tr> <tr> <td>SH2</td> <td>3½"</td> <td>13½"</td> <td>26 lbs.</td> </tr> </table>	No.	Bit Length	Hdle. Length	Weight Per Doz.	SH2	3½"	13½"	26 lbs.				
No.	Bit Length	Hdle. Length	Weight Per Doz.																											
535	2¾"	12"	17 lbs.																											
No.	Bit Length	Hdle. Length	Weight Per Doz.																											
3005	2½"	12"	15 lbs.																											
No.	Bit Length	Hdle. Length	Weight Per Doz.																											
SH2	3½"	13½"	26 lbs.																											

All the Above Hatchets Regularly Packed 1/3 Dozen to a Box.

Figure 21a—Some 20th-century Plumb hatchets and hand axes.





## PLUMB HATCHETS AND HAND AXES

Advertised Finish—Smooth Black Head and tested Red Handle  
 All Plumb Hatchets have PERMABOND Handle Assembly  
 PERMABOND is a Revolutionary New Chemical Weld that Binds Head to Handle Permanently  
 These Hatchets are designed to do a specific job. With cutting edges that stay sharp, they are perfectly balanced for easy accurate work.

These light-weight hand axes are easy to use in chopping kindling and cutting stakes. Yet, the heads are sturdy enough to pound and drive. Tempered to withstand numerous sharpenings.

### PLUMB CALIFORNIA LATH HATCHET



Polished Finish, Thin Blade, Checkered Oval Head, Red Handle

No.	Bit Length	Hdle. Length	Weight Per Doz.
3025	2 1/8"	12 1/2"	18 lbs.

### PLUMB BOX HATCHETS



Polished Finish, Checkered Oval Head, Red Handle

No.	Bit Length	Hdle. Length	Weight Per Doz.
2	2 1/8"	13"	18 lbs.
3	2 1/4"	16"	24 lbs.
4	2 1/4"	13"	21 lbs.

### PLUMB WALLBOARD HATCHET



Polished Finish, Red Handle Crowned Face with Flat Checkers

No.	Bit Length	Hdle. Length	Weight Per Doz.
3020	2 1/4"	13"	21 lbs.

### PLUMB EXPERT SHINGLERS HATCHET

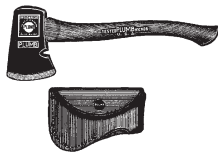


Advertised Finish With Shingle Gauge and Leather Strap

No.	Gauge Holes	Bit Length	Hdle. Length	Weight Per Doz.
565 1/2	5	2 1/4"	13"	23 lbs.

Extra Gauge for above Hatchet

### PLUMB BELT AXES



Advertised Finish

No.	Hdle. Length	Weight Per Doz.
680, without sheath	14"	1 1/4 lbs.
682, with sheath	14"	1 1/4 lbs.

### NATIONAL AXE



Black Head with Blade Ground and Polished Fan Shape and Tested Red Handle. All Purpose or General Utility Axe

No.	Hdle. Length	Weight Per Doz.
666	16"	1 3/4 lbs.

### PLUMB HOUSE AXE



Advertised Finish

No.	Hdle. Length	Weight Per Doz.
665	19"	2 1/4 lbs.

### PLUMB HUNTERS' AXES



Advertised Finish

No.	Hdle. Length	Weight Per Doz.
672	14"	1 1/4 lbs.
674	16"	1 3/4 lbs.

### STORM KING HUNTERS' AND HOUSE AXES



Red Head, with Raced Bit White Lacquered Handle

No.	Hdle. Length	Weight Per Doz.
House SK 665	19"	2 1/4 lbs.
Hunter's—SK 672	14"	1 1/4 lbs.
Hunter's—SK 674	16"	1 3/4 lbs.

### NATIONAL BOYS' AXE



Black Head with Blade Ground and Polished Fan Shape and Tested Red Handle. A Light Weight Chopping Axe

No.	Hdle. Length	Weight Per Doz.
667	28"	2 1/4 lbs.

### PLUMB BOYS' AXE



Advertised Finish

No.	Hdle. Length	Weight Per Doz.
662	28"	2 1/4 lbs.

### STORM KING BOYS' AXE



Red Head, with Raced Bit White Lacquered Handle

No.	Hdle. Length	Weight Per Doz.
SK 662	28"	2 1/4 lbs.

All Hatchets and Boys' Axes Packed 1/3 Dozen to a Box. All Other Axes Packed 1/2 Dozen.

Some axes weren't used for cutting wood. Ice axes were used to cut ice from lakes in the winter so the ice could be used for refrigeration during the summer (Figure 23). Sod or turf axes were used to chop sod for sod houses (Figure 24). People have used axes as a weapon for centuries. Fire axes are used to break down doors to enter burning buildings. The Pulaski is an ax tool used to fight wildland fires (Figure 25). An ax known as a butchering ax was used to kill cattle (Figure 26). Axes called "salesman samples" were miniature versions of full-size axes. Salesmen would carry them to hardware stores to demonstrate their wares.



Figure 23—A 19th-century ice ax for harvesting pond ice.

Figure 21b—More 20th-century Plumb hatchets and hand axes.

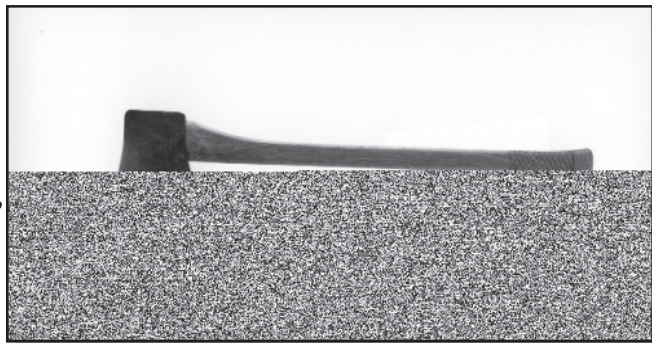


Figure 22—A Tuatahi competition ax. This New Zealand company specializes in custom-made axes and competition crosscut saws.

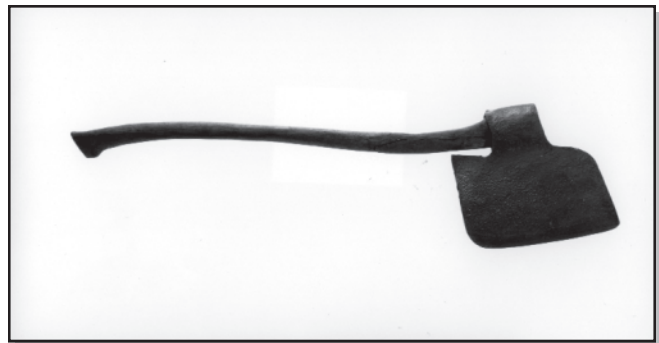


Figure 24—A 19th-century sod ax for building sod houses.

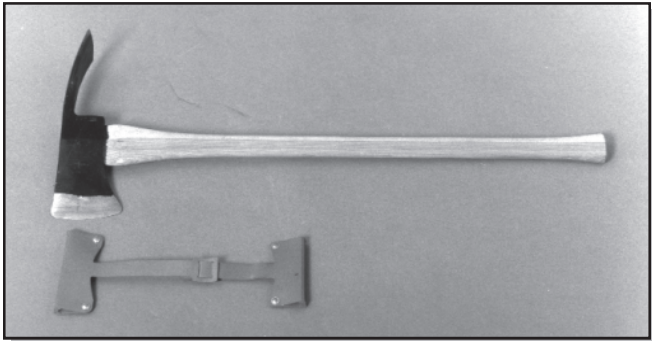


Figure 25—The Pulaski is a popular wildland firefighting tool that combines an ax with a grubbing hoe.



Figure 26—A 19th-century butchering ax.

## Adzes

The adz is another hewing or dressing tool (Figures 27a, b, c, and d). It has a head that gives it the appearance of a hoe, but it is tempered and sharpened to cut wood. The adz is primarily used for dressing or planing timber that has been hewn by a broad ax. An adz is used for the final dressing in some of our finer hand-built structures.

Figure 27a—Collins lipped shipwright's adz.



Figure 27b—Plumb railroad adz.



Figure 27c—Modern carving ax or adz.



Figure 27d—Douglas carpenter's adz.



## Decline of the American Ax

Some of the leading American ax companies have included: Collins Company, Mann Edge Tool, Kelly Axe or True Temper Kelly, Plumb Axes, and American Axe and Tool Company. When factory production first began, axes were produced by individual blacksmiths hired to make a complete ax. Gradually an assembly line was introduced. Improved steels and more efficient forging processes took most of the hand labor out of ax manufacture. The manufacturing process and materials evolved from individual blacksmiths hammering out axes one at a time to the giant drop hammers used today to stamp out fully formed ax heads.

During the 19th century, axes provided the best technology to meet the needs of the burgeoning forest products industry. Manufacturers produced hundreds of patterns for both general utility and specialized uses.

The use of American axes and their quality were probably at their peak during the period from 1850 to 1950 (Figure 28). Beginning about 1870, ax production began to drop due to the increased use of the crosscut saw as a felling tool. The ax continued to play an important role for swamping and limbing trees, but its role was diminished.



Figure 28—During the heyday of American axes, companies went to great lengths to promote their axes, like this Kelly “Best Axe Made” broad ax.

The introduction of the power saw was the death knell of the ax and the crosscut saw. By the late 1950’s and early 1960’s, lightweight, efficient chain saws had taken over almost all of the work that previously had been accomplished with an ax—felling, bucking, and limbing.

If you search the Internet for ax, axe, or axes, you will probably find more sites related to guitars (referred to as “ax”) than you will to those dealing with cold, hard steel. But if you focus on work in the woods rather than on the Internet, you will see that the ax still occupies an important place as a woodworking tool.

A Swedish company, Gränsfors Bruks AB, still manufactures hand-forged axes (Figure 29). Gabriel Brånby of Gränsfors Bruks provides a good summary of the modern role of the ax (Gränsfors Bruks 1997):

*In a certain way we are back at the time before the entry of the booming forest industry. There are no axe-using forest workers any longer. The millions of cubic feet of pulpwood and timber that today arrive at the forest industries have never been grazed by an axe. The chain saws, harvesters and logging machines have taken over completely. Today most axes are used in small-scale activity by people like homeowners, firewood cutters, campers, hunters, joiners, woodworkers, log builders.*

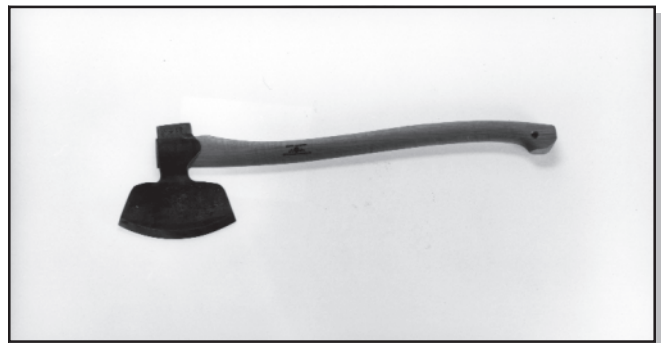


Figure 29—Modern hand-forged broad ax made by the Swedish Company, Gränsfors Bruks AB.



Figure 30—This modern blacksmith-made trade hatchet might be just the right gift for your sweetheart on Valentine's Day.

Thousands of new axes are sold every year, mostly for the activities Brånby describes. Some historic axes are sold or traded by collectors (Figure 30). In the Forest Service, axes still play a critical role in designated wilderness areas where mechanized or motorized equipment is prohibited by law. In these areas, axes, adzes, and crosscut saws are needed for clearing trails, cutting firewood, managing forest fires, and maintaining or restoring administrative buildings.

Outside wilderness, axes and adzes are used for historic building restoration and as lightweight, convenient, affordable alternatives to chain saws. To at least a few recreational wood cutters and craftsmen, the rhythmic sound and motion of chopping are more appealing than the whine and exhaust of a chain saw.

This look at the history of the ax and its evolution in North America is not complete. Four excellent references for more detailed study are: Henry J. Kauffman's *American Axes* (1994); Charles A. Heavrin's *The Ax and Man* (1997); Alan Klenman's *Ax Makers of North America*, and Henry Mercer's *Ancient Carpenter's Tools* (1960). Full citations for these sources are in *Selected References*.



**B**rief History of the Ax



# Getting the Hang of It

The length, shape, and mounting of an ax handle (also called a helve or haft) is known as the hang. The hang of an ax is always a matter of personal preference. You must hang your ax to suit you. The cutting edge of a well-hung ax is in an exact line with the end of the handle (Figure 31). If you place the ax on a table so that the cutting edge and the handle touch the surface, the cutting edge will touch at a point one-third from the heel (Figure 32).

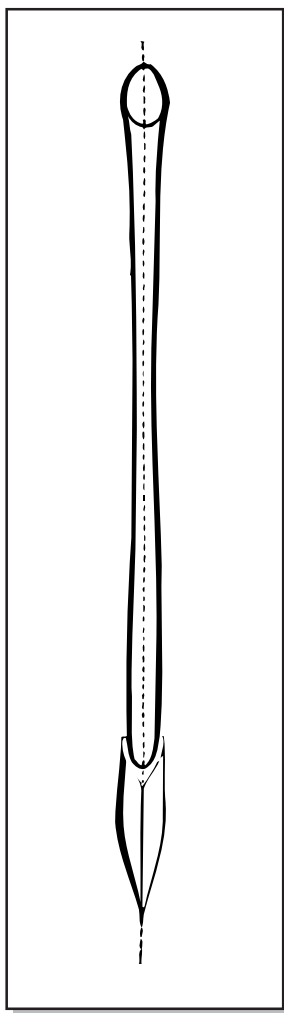


Figure 31—In a correctly hung ax, the cutting edge is in a direct line with the center of the handle (from the *Axe Manual of Peter McLaren*).

In addition to having the blade aligned and set at the correct angle, a properly hung ax just feels right. The head is neither too heavy nor too light, and the handle is just the right length. The handle may be curved or straight, depending on your preference. The handle's diameter should feel comfortable to the grip, and the handle should be constructed from the highest quality hickory. I personally prefer a slim-taper octagonal handle. I get a good grip, or purchase, on the slim handle and it has a bit of flex to it, unlike thicker handles.

Many years ago, before the proliferation of mass-produced axes, most users selected and handled their own axes. Professionals who worked with axes were

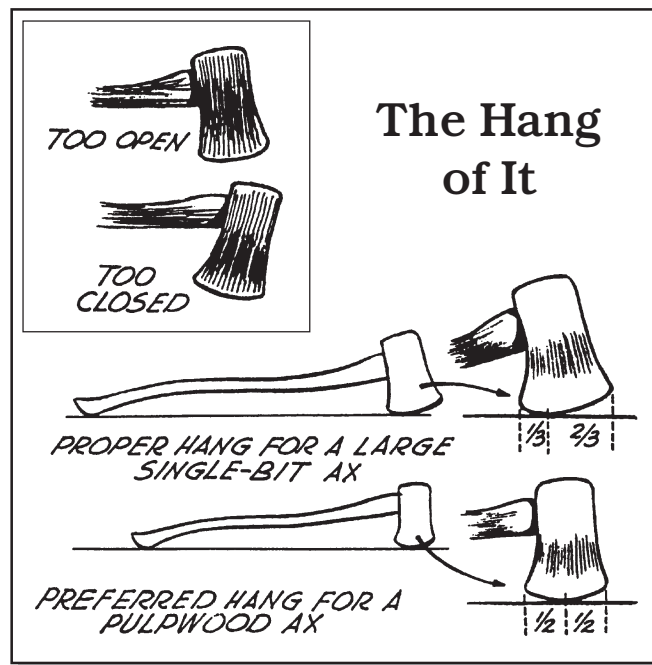
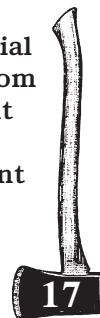


Figure 32—Proper ax-head angle (drawing by Frederic H. Kock).

very particular about the weight, length, design, geometry, flexibility, and most importantly, the hang of their axes. Such attention allowed them to work faster and made the task easier.

Most felling axes and broad axes were not regularly sold with handles until about 1920. The purchaser generally took pride in making and fitting, or hanging, his or her own handle. Many people made patterns of the handle they used on a thin board. Sometimes this pattern was handed down through the family. Some of these patterns still exist and can be found in old barns and workshops.

Throughout history, hickory has always been the preferred wood for percussion tools like axes, mauls, and hammers. In the 18th century, hickory was probably split instead of sawn to obtain a straight and continuous grain essential for a quality tool handle. Surviving handles from the 17th century show that most were straight patterns, without the swell at the end of the handle as is common on both straight and bent handles today (Figures 33 and 34a, b, and c).














	<b>BENT SINGLE BIT</b> 36" - No. 100 (Pat.No. 1-36) for 3 to 5 lb. axes 34" - No. 101 (Pat.No. 1-34) for 3 to 5 lb. axes 32" - No. 102 (Pat.No. 1-32) for 3 to 5 lb. axes 30" - No. 103 (Pat.No. 1-30) for 3 to 5 lb. axes 28" - No. 104 (Pat.No. 1-28) for 3 to 5 lb. axes
	<b>OCTAGON SCROLLED BENT SINGLE BIT</b> Catalog Price Group 1 36" - No. 115 (Pat.No. 1-36-0S) for 3 to 5 lb. axes
	<b>BOYS SINGLE BIT</b> Catalog Price Group 2 28" - No. 116 (Pat.No. 8-28) for 2-1/4 lb. axes 26" - No. 117 (Pat.No. 8-26) for 2-1/4 lb. axes
	<b>HOUSE AXE</b> Catalog Price Group 24 18" - No. 118 (Pat.No. 8-18) for 2-1/4 lb. axes
	<b>DOUBLE BIT</b> 36" - No. 140 (Pat.No. 2-36) for 3 to 5 lb. axes 34" - No. 141 (Pat.No. 2-34) for 3 to 5 lb. axes 32" - No. 142 (Pat.No. 2-32) for 3 to 5 lb. axes 30" - No. 143 (Pat.No. 2-30) for 3 to 5 lb. axes 28" - No. 144 (Pat.No. 2-28) for 3 to 5 lb. axes
	<b>CRUISER'S DOUBLE BIT OR CEDAR AXE</b> 28" - No. 145 (Pat.No. 9-28) for 2-1/2 lb. axes
	<b>STRAIGHT SINGLE BIT</b> 36" - No. 119 (Pat.No. 5-36) for 3 to 5 lb. axes 34" - No. 120 (Pat.No. 5-34) for 3 to 5 lb. axes 32" - No. 121 (Pat.No. 5-32) for 3 to 5 lb. axes
	<b>MINERS STRAIGHT SINGLE BIT</b> 27" - No. 124 (Pat.No. 5-27) for 3 to 5 lb. axes 20" - No. 128 (Pat.No. 5-20) for 3 to 5 lb. axes
	<b>NEW ENGLAND SINGLE BIT</b> (Slim Body) Catalog Price Group 1 30" - No. 160 (Pat.No. 12-30) for 3 to 5 lb. axes 28" - No. 161 (Pat.No. 12-28) for 3 to 5 lb. axes

Figure 33—Some ax handles available in 1999 from O.P. Link Handle Company (reprinted by permission from O.P. Link Handle Company).

Today, few ax users hang their own axes. Most professionals in ax competitions hang their own axes, as do some professional woods workers and craftsmen.

Most axes with broken handles are thrown out or relegated to a dusty corner of the garage and replaced with a new ax from the local discount store. Often the ax heads thrown into the corner are of much higher quality (better steel, craftsmanship, temper) than most generic axes sold by mass marketers today.

In my opinion, folks who take any pride in their ax skills need to know how to hang and sharpen an ax. They should know how to make emergency repairs in the field, and they should know how to sharpen and care for their axes to keep them safe and tuned for peak performance. The most important reason for acquiring these skills is one of attitude. By hanging and sharpening your own ax, you realize it is your ax, not just a hunk of wood and metal. And you are more likely to take care of the ax and use it safely.



Figure 34b—A 19th-century S-bend broad ax handle.



Figure 34a—Modern S-bend broad ax handle.



Figure 34c—A 19th-century dogleg broad ax handle.



## Basics of Handle Selection

Hickory makes the best handles for percussion tools like axes. You seldom see any species other than hickory offered by ax-handle companies.

There are several important characteristics you need to look for in a good ax handle. Generally, you get what you pay for, because the higher grade hickory handles sell at a premium over lower grade handles. Your new handle should be of straight grain, second growth, clear hickory. Cheap, inferior handles tend to break, split, and warp. If you are going through all the work of hanging your own ax, you should spend the extra dollars to get a high-quality handle. Some characteristics you need to look at include:

**Color:** The best handles are from second growth hickory sapwood, all white in color (Figure 35). In lower grades, various amounts of red-colored heartwood are in the handle.

**Grain:** The highest grade does not have over 17



Figure 35—Hickory cross section. The outer, white sapwood makes the best ax handles. This particular piece is too small and too riddled with checks to be good handle stock.

annual rings per inch of radius, a characteristic of faster-growing second growth trees. The orientation of the grain is critically important (Figures 36 and 37). If the handle is not straight-grained, it is likely to break.

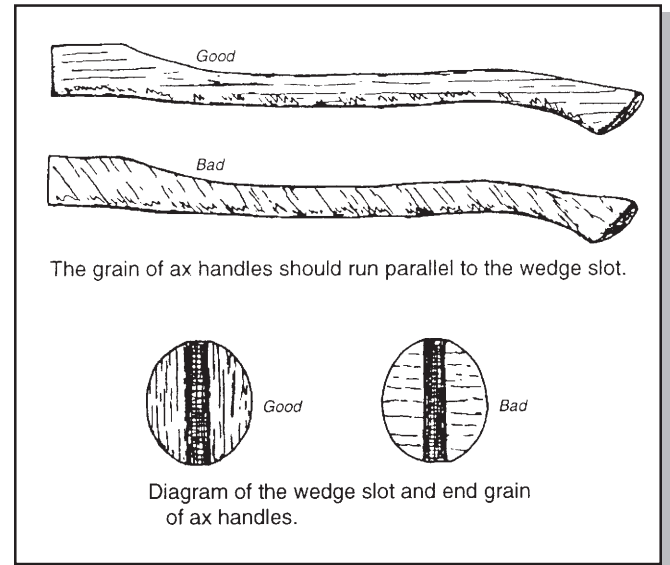


Figure 36—The grain of ax handles should run parallel to the length of the handle and to the wedge slot.



Figure 37—Grain orientation is important. The handle on the left has a good orientation. The one on the right does not, and is more likely to break under stress.



**Defects:** Various defects, including stain, holes, knots, splits, streaks, and grain deviations all diminish the grade of the handle.

**Camouflaged Defects:** Many less-than-perfect ax handles, often on bargain or utility axes, have defects that are camouflaged. This often helps make the ax look better, but you should recognize that good looks can hide defects. Some common techniques include staining, painting, or fire-finishing, which hardens and darkens the handle's surface.

Handles come in a variety of lengths, typically from 32 to 36 inches for 3- to 6-pound axes (Figure 38). Often the longer lengths work best for big timber and for splitting wood, while the shorter lengths are superior for smaller timber and general utility work. Handles (Figure 39) can be straight or curved (called a fawn's foot). Double-bit handles are almost always straight, but for single-bit axes you can choose either curved or straight handles. My personal preference is a straight handle, usually less than

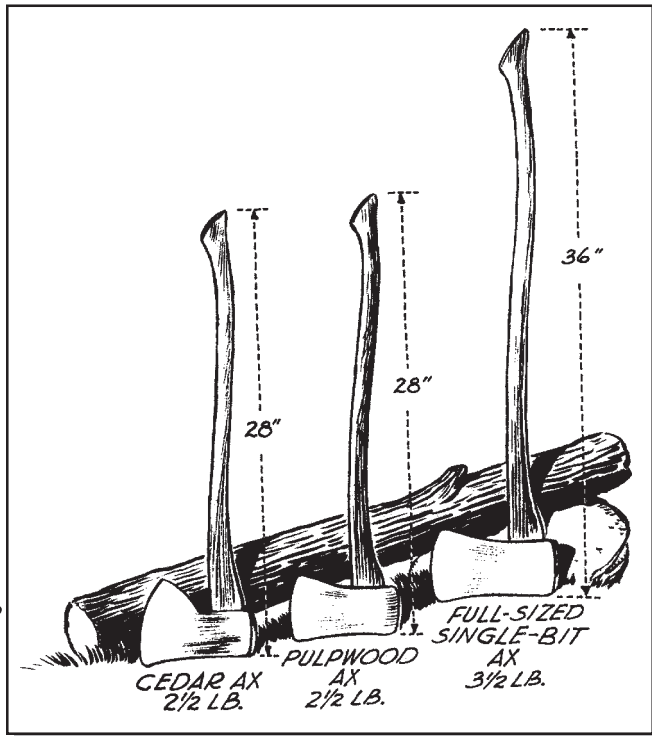


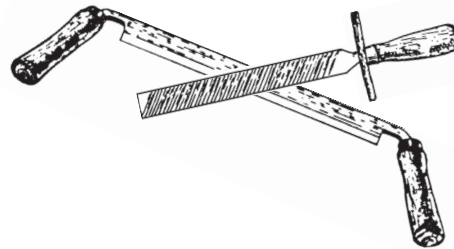
Figure 38—Longer handles with heavier heads are for big timber. Most choppers prefer shorter, lighter axes for smaller wood (drawing by Frederic H. Kock).

36 inches long. The handle can be oval or octagonal. I special order O.P. Link handles in a slim-taper, octagonal pattern, a design not found in their general catalog but one the company makes for me from the hundreds of patterns they have on file.



Figure 39—Some ax handles, from top: double-bit with too much heartwood; handmade 19th-century single-bit; the next three are new single-bit handles from O.P. Link—fawn's foot octagonal, straight oval, and my favorite, straight octagonal slim-taper.

Most ax manufacturers also offer axes with fiberglass or other plastic composite handles. While these may be durable and sturdy and perhaps adequate for splitting mauls, they do not provide the feel that a hickory handle offers. You also cannot customize a fiberglass handle. They are not traditional, which matters to me. And besides, they are just flat ugly.



## Hanging Procedure

**F**irst, check to see whether you really need a new handle. Often you can reuse the same handle and just replace a loose wedge.



Figure 40—Tools needed for hanging an ax include (clockwise, from top left): leather gloves, four-in-hand rasp, wood rasp, keyhole rasp, steel drift for double-bit ax, steel drift for single-bit ax, hickory drift made from old handle, spokeshave, coping saw, and wooden mallet.

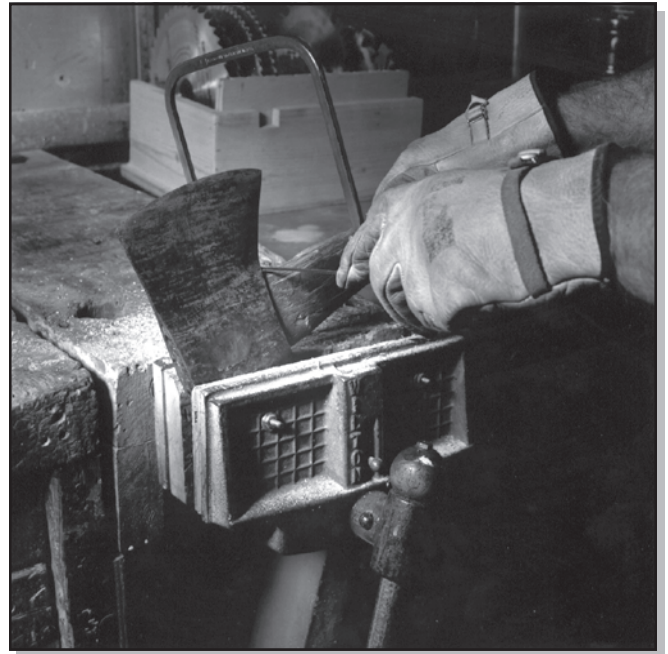
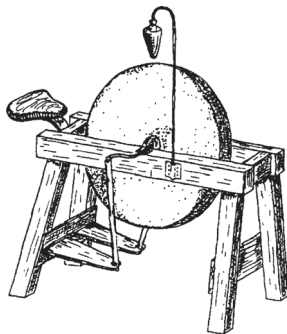


Figure 41—Cut off the old handle just below the ax eye, close up against the head, with a coping saw. Remove any steel wedges or screws that may be in the top of the handle at this time.

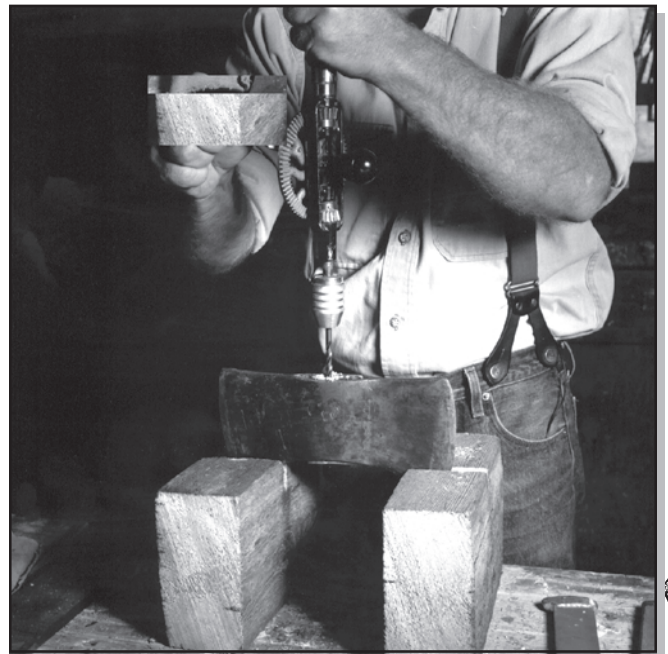


Figure 42—Drill out the wooden wedge and part of the handle from the top side of the ax eye. Power drills work, too.

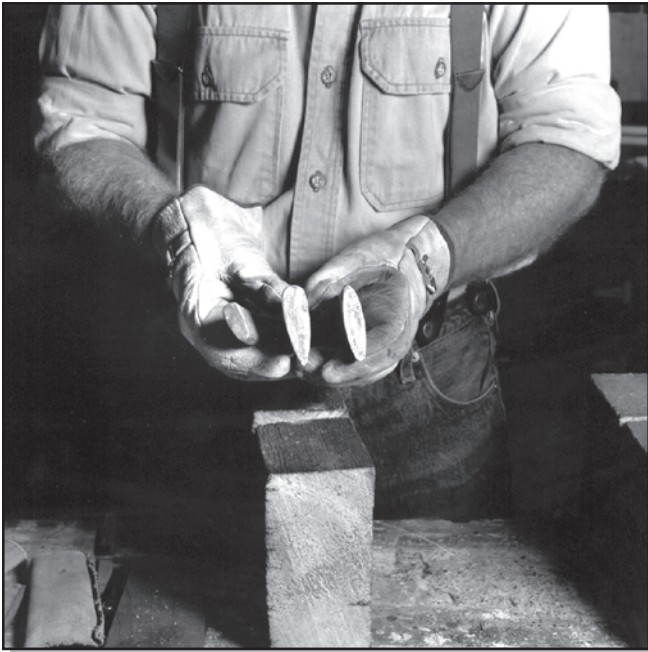


Figure 43—Use a wooden or steel drift or swedge to drive out the remainder of the handle. Notice the drift in the center is shaped for a single-bit ax, the one on the right is for a double-bit ax.



Figure 45—If you use a fawn's foot handle, saw off the handle about  $\frac{3}{4}$  inch from the butt end to provide a blunt surface for pounding with your mallet (drawing by Frederic H. Kock).



Figure 44 —Block up the ax head upside down. Drive the drift down through the bottom of the ax eye toward the top of the ax eye. The ax eye is tapered larger on the top to facilitate wedging the handle tight. This taper requires the old handle piece to be driven out the top of the ax eye.



Figure 46—Take the new handle and place it next to the ax head. Bring the shoulder of the new handle all the way up to the bottom of the ax eye in its finished mounting location. This usually leaves quite a bit of excess wood on top. Draw a line to show where the excess wood should be cut off.

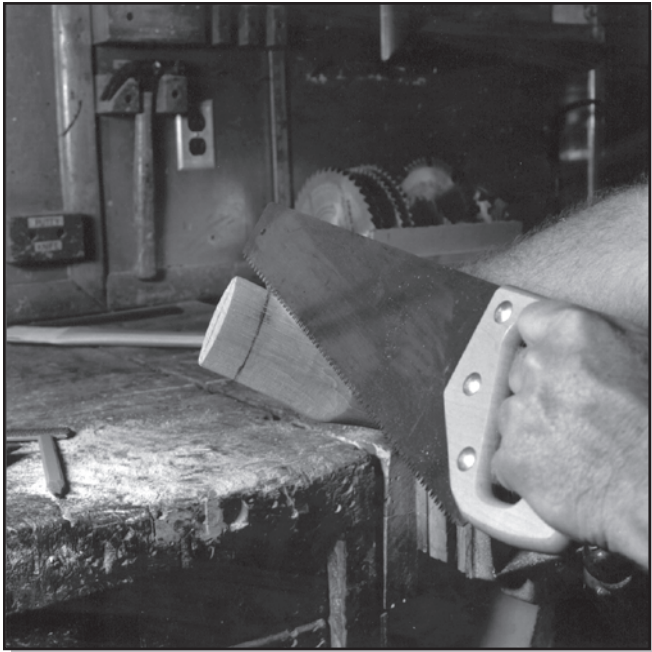


Figure 47—With the handle in the vise, use a hand saw to cut off the excess wood. Be careful not to split the handle.



Figure 49—When the ax is properly hung, the bottom of the ax eye should rest on the shoulder of the handle. Drive the new handle into your ax head for a trial fit. Place the handle in the eye socket from the bottom. Use a large wooden mallet to strike the bottom of the handle squarely and firmly. This will draw the weight of the ax head up onto the handle. There's no need to rest the ax head or the handle against a solid base. Sight down the cutting edge to see if the ax edge is in exact line with the end of the handle (See Figure 31).



Figure 48—Using an aggressive wood rasp or a four-in-hand, start dressing down the handle to fit the ax-eye socket tightly. At this point, be careful not to split off the edges of the handle or to rasp off too much wood. Once it's rasped off, it can't be put back! It usually takes several repetitions of rasping and checking for fit to get everything just right.

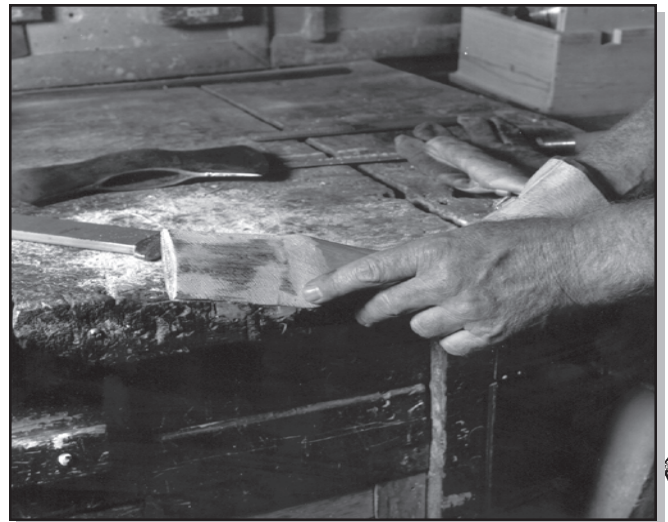


Figure 50—Drive the handle out again using a drift, and take one final rasp for a good tight fit down on the shoulder. The ax head will leave marks on the high spots that need additional light rasping.



Figure 51—Since you've cut off the excess portion of the new handle, the wedge kerf slot is too shallow and must be deepened. Use a hand saw to cut the saw kerf deeper for the wood wedge. The cut should be approximately two-thirds the depth of the ax eye.



Figure 53—This handle is properly mounted on the shoulder. Compare this photo with the untrimmed handles in Figure 39 to see how low on the shoulder this ax head is mounted. There is no excess shoulder, and the handle is ready to be wedged.

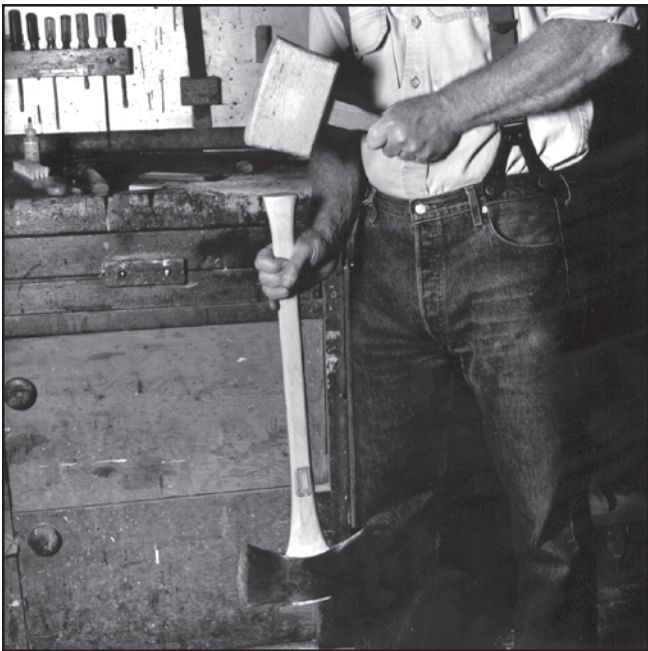


Figure 52—Time for the final fit. Drive the head on by striking the bottom of the handle. You can often tell when the head will move no farther by the solid sound of the strike.



Figure 54—With a coping saw, cut the protruding handle flush with the ax head.



Figure 55—The fitted handle is ready for wedging. Use a correctly sized wooden wedge, usually made of well-seasoned yellow poplar or other hardwood. Avoid plastic or steel wedges.



Figure 57—Before inserting the wedge in the handle, apply a coat of Swel-Lock to the inside kerf cut and the new wooden wedge. Swel-Lock is a product that swells wood. It is not a glue or an adhesive; rather, it penetrates and expands wood fibers to keep the new handle tight.



Figure 56—Sometimes the wedge is too thick for the saw kerf and ax eye. If so, thin the wedge out a little bit so that it can be driven almost full length.



Figure 58—Insert the wooden wedge. Rest the handle bottom on something solid. Drive the wedge squarely and firmly into the kerf with a wooden carpenter's mallet. If you have set everything up properly, there should only be  $\frac{1}{4}$  to  $\frac{1}{2}$  inch of wedge protruding above the top of the handle when the wedge has been driven to the point of refusal. Use a coping saw to cut off any excess wedge.

Never insert iron, steel, screws, nails, or any other metal object down in the wooden wedge to tighten the handle, even though you see this being done on many factory-handled axes. Epoxy should not be used, either. This advice applies for the entire life of your ax. The metal wedges tend to split the grain on the hickory handle. I can't see any reason why you would want to do that to a properly hung ax.

A loose handle can be temporarily tightened either in the field or in the shop by soaking the head in a bucket of linseed oil. Never soak the handle in water, except for short-term, emergency field tightening. Water will tighten the handle to the head, but the water dries out rapidly, leaving the head looser than before you started. Tightening the handle by soaking it in linseed oil is also a temporary measure. The ax must be rewedged or hung again to keep it tight.

## Sharpening



Figure 59—Sand any paint, varnish, shellac, or wax from the handle. Sand the handle smooth on all but 6 inches of the butt section. The body of the sanded handle is where your hand will slide. You don't want any splinters or rough wood there.



Figure 60—Rough up the lower 6 inches of the butt section of the handle with a wood rasp. This rough section will give purchase, or grip, to your stationary hand at the bottom of the ax handle.



Figure 61—Apply a light coat of raw linseed oil if it is available, or boiled linseed oil if it is not. Tung oil will also work. A regular application of these oils will protect against drying and cracking. Wipe off the excess oil.



**W**ith oil and rags, there is a risk of spontaneous combustion. Be sure to discard the oily rags or soak them in buckets of water to prevent any accidents.

“Putting your nose to the grindstone” implies tedious, repetitious, and unending work. You will find that sharpening a dull or abused ax is indeed tedious and repetitious, but to do it right you have to do it slowly (Figure 62). Along the way, you’ll learn the value of patience, and appreciate the differences in steel tempering and ax quality as you sharpen different axes. Best of all, you will appreciate the usefulness of a razor-sharp ax, and the importance of doing everything you can to keep it sharp.

Never use an electric high-speed dry bench grinder

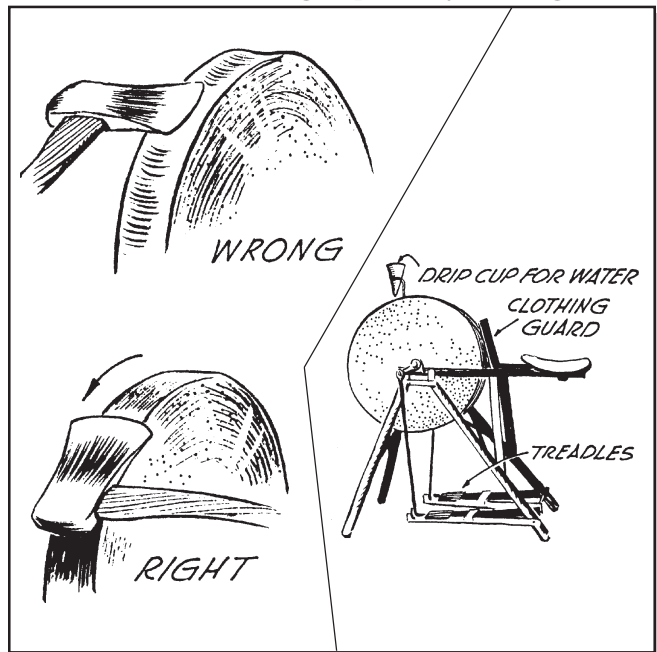


Figure 62—The right way and wrong way to use a grinding wheel (drawings by Frederic H. Kock).

to sharpen your ax. That type of a grinder will almost certainly draw the temper from the ax and ruin it. Very few people have enough skill to use a high-speed grinder without drawing the temper from the steel, leaving the steel too soft to hold an edge. The only grindstone that I recommend is one of the old-style pedal grindstones that stay wet with a constant application of water to the stone. If you draw the temper from your ax with a high-speed grinder, you may have ruined the ax for good. At the minimum, you’ve drawn the temper for at least  $\frac{3}{16}$  of an inch back from the edge. You can always tell when the temper is drawn because the color of the steel at the edge turns blue. If this happens to your ax, you’ve got to remove a lot of steel to reshape the edge back to where it still is tempered. If you use a pedal grindstone, keep it wet, and always rotate the grindstone toward you and into the ax, not away from it.

If you don’t have a pedal grindstone, your options are limited to a file and whetstone. This is how most quality ax sharpening is done today. Few stores carry pedal grindstones. Wear leather gloves (Figure 63) throughout the sharpening process, as the ax will become razor-sharp.



Figure 63 —Tools for sharpening (clockwise from top left) include leather gloves; ax-bit width gauges; 8-inch, 10-inch, and 12-inch mill bastard files; Carborundum scythe stone; Carborundum ax stone; file card; and grooved Carborundum sharpening stone. Natural Arkansas sharpening stones also work.

Fit your file with a guard to protect your hands (Figure 64). The guards, which keep your fingers away from the sharpened ax blade, can be made from leather, wood, or a piece of fire hose.

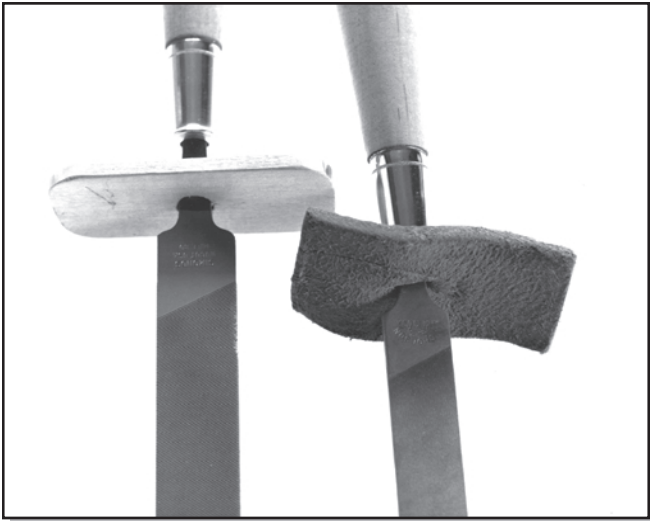


Figure 64—File guards help keep your fingers away from the sharpened ax blade.

Clamp the ax to the bench at a comfortable height (Figure 65). Put on gloves to protect your hands. Hold the file as shown. Because you file into the edge of the ax, not away from it, you need gloves in case of a minor slip. Always file into the edge, toward the center of the ax handle, because this creates the least amount of burr to remove on the other side. The single-cut file sharpens only on the push stroke. Lift it away from the ax head on the return stroke. If you “saw” with your file, it will fill with metal particles. It will not cut well and it can also be ruined as the file edges are peened over. Occasionally brush the metal particles from the file with a file card. Always store and transport your files so they are protected from each other and other metal tools. Banging them together will dull their edges.

When sharpening, always try for a fan-shaped effect on the cheek of the ax (Figure 66). File back for a distance of approximately 2 to 3 inches from the cutting edge right at the middle point of the ax. Work your way from the cheek down to the actual edge, keeping a rounded profile. Stop filing once you have filed one side so that a burr of metal can be felt on the back side. Turn the ax



Figure 65—Clamp the ax to the bench at a comfortable height for sharpening.

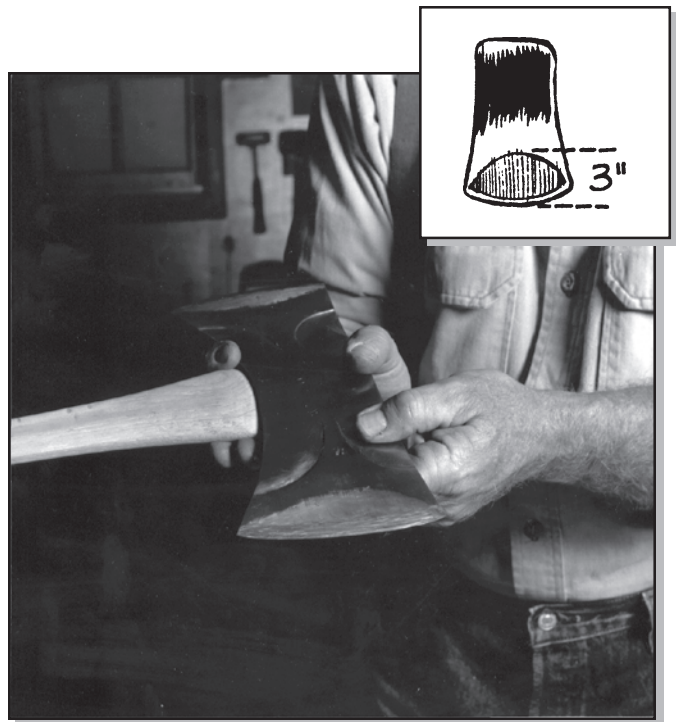


Figure 66—When sharpening, try for a fan-shaped effect on the cheek of the ax (drawing by Frederic H. Kock).

over and repeat the process on the other side of the ax. Continue filing on the opposite side until the burr goes back over to the first side of the ax where you started. Stop at this point.

It is time to check the shape of the edge with a sharpening gauge (Figure 67). This gauge can be handmade from a piece of cardboard, a small piece of brass, or even a piece of wood. See the illustration for the proper shape of your edge. The angle is about 25 degrees, but is slightly convex. The gauge is exactly to scale and can serve as a template (Figure 68).

Continue to file equally on both sides of the ax until the sharpening gauge pattern fits exactly



Figure 67—Use a sharpening gauge to check the shape of the edge.

over the edge. If you are sharpening a double-bit ax, keep one blade slightly thicker for rough work and grubbing near the ground, and the other blade shaped according to the sharpening gauge. Use the properly shaped edge for fast, clean cutting.

Now it is time to hone the edge with a whetstone. The honing process finishes and polishes the

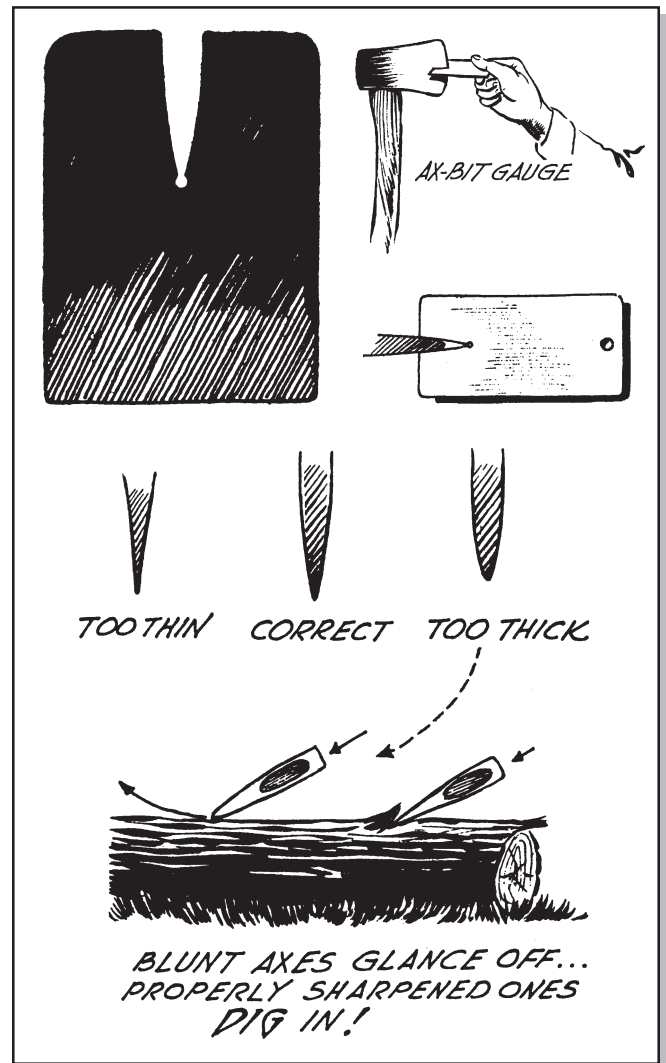


Figure 68—A template for a sharpening gauge (reproduced to exact size) and illustrations showing its use (drawings by Frederic H. Kock).

edge and removes the burr. Honing should always be done immediately after reshaping with a file. It should also be done in the field during use and every morning before starting the day's ax work. Natural whetstones are quarry stones. My favorites are Arkansas stones, which come in different grades. The Washita is my favorite for fast cutting and the Hard Arkansas is my favorite for finishing. One of the finest finishing oil stones is called a Surgical Black Hard Arkansas. This stone will



put a razor edge on your ax. Manmade stones are usually oil stones of Carborundum and come with a coarse and a fine side. Other whetstones are called water stones and use water to float the metal particles out of the stone instead of oil. Always use oil with an oil stone or water with a water stone to float the metal particles away. Wipe the stone clean of these metal particles periodically and apply more oil or water. Water stones are quite a bit softer than oil stones and tend to cup and wear faster. The advantage of the water stone is that it rapidly puts a fine polished edge on your ax.

Round artificial ax stones (Figure 69) are sometimes called pocket stones. I know of two types. The traditional type has both a coarse and a fine side and is about  $\frac{1}{2}$  inch thick. This traditional ax stone can be dangerous to use, because your fingertips are always in jeopardy. Another type of ax stone has a finger groove in the center to keep your fingertips out of jeopardy. Both of these round ax stones are of Carborundum and require oil (Figure 70) to float the metal particles off of the stone.



Figure 69—Round ax stones, sometimes called pocket stones.



Figure 70—Use oil to float metal particles off ax stones made of Carborundum.

Use the ax stone in a circular motion, working into the edge, toward the middle of the ax head (Figure 71). Work one side of the ax with the coarse stone until it creates a metal burr, then flip the ax over and use the coarse stone until it pushes the burr back. Switch to the fine side of the ax stone and repeat the process until there's a very fine burr and both sides of the ax edge have been honed. Honing the edge removes very small particles of metal from the blade and causes the remaining ax metal to burr slightly. This is sometimes known as a wire edge or a feather edge. At this point you may want to move to one of the Arkansas stones like the Hard Arkansas finishing stone and work the burr back and forth until it breaks off or becomes very fine. I recommend stropping the edge by drawing the ax toward the edge (opposite the direction used during sharpening) on a piece of finished leather or a piece of soft, clear wood like pine. This stropping will remove the final burr or wire edge.

The last step is to apply a protective coating to

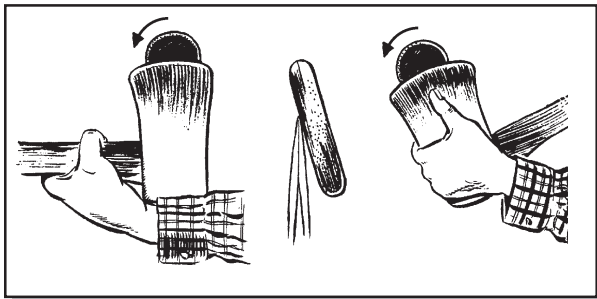


Figure 71—Use the ax stone in a circular motion, working into the edge, toward the middle of the ax head (drawings by Frederic H. Kock).

the ax head itself (Figure 72). You can clean the rust and pitch from the metal with an abrasive impregnated rubber eraser block called the Wonderbar. Wipe light machine oil over all the metal on both sides of the ax, and then carefully rub a beeswax and oil mixture into the steel. The mixture will cling to the steel and protect it from rust. The ax head should be warm to ensure better coverage of the mixture.

Always check the ax for sharpness. A honed ax will cut faster, be safer to use, and stay sharp longer. If you look directly into the edge of your ax with the light over your shoulder (either sunlight or artificial light), the edge that you've just honed will reflect no light. If you see any light reflected from the edge, you need to go back and hone the ax with the stone. Occasionally, a ding or a nick in the edge will reflect light just at one point. It is not always necessary to remove

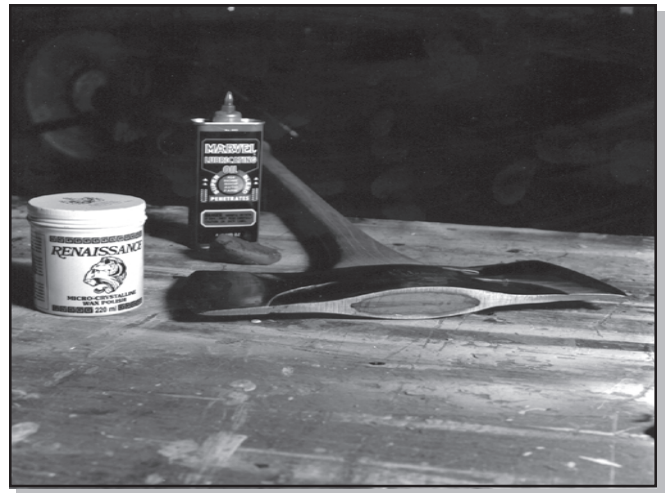


Figure 72—Protective coatings for the ax head.

these dings as they will disappear through repeated filings. A correctly honed edge is sharp with no wire edge. It reflects no light. If you followed procedures, your edge should be sharp enough to shave with (Figure 73). I sometimes check the sharpness by carefully dry shaving the hair on the back of



Figure 73—Shaving hair on the back of your hand is a traditional method of checking an ax's sharpness. A safer method is to place your fingernail against the edge. The edge should bite into your fingernail.



## Getting the Hang of It



my hand. This is a traditional method used in the woods for years. A safer and equally effective test is to carefully put your fingernail (not your finger)

against the sharpened edge. The edge should bite into your fingernail and not slide down it.



# Using Axes

## A Most Versatile Tool

The ax is a wonderful tool. It can be used to fell standing trees, to buck them into logs, and to limb them once they are on the ground. Axes can be used for hewing logs square, or for splitting firewood or fence rails. The tasks they're suited for range from trail work and fire fighting to restoring historic buildings.

Before you lift an ax to admire it or work with it, you need to recognize its potential danger. An ax is a sharp wedge, normally applied with enough force to cut something. Whether that "something" is a log, your foot, or the person standing too close to you depends on your skill and concentration. By taking pride in your work, taking good care of your ax, and learning the correct techniques, you can avoid most of the danger of using an ax.

Master your ax instead of fearing it. You master ax work by practicing it. Chopping is an art. It takes years to become an expert. You can learn only so much by reading manuals and looking at illustrations; the rest you can learn only by swinging. Take a cautious, rather than aggressive, approach to chopping your first logs. Placement, control, proper stance, and technique are far more important than power. Only when you have become fully proficient does power become a consideration.

This chapter gives some basic instruction—and a few tricks of the trade—for using an ax for felling, limbing, bucking, splitting, and hewing. It also describes how to use an adz for log work. I've relied heavily on illustrations from one of my favorite books about axes, *Woodsmanship*, by Bernard S. Mason (1954). The wonderful illustrations are by Frederic H. Kock. Unfortunately, it is long out of print, but some of the illustrations are reproduced here by permission. We also used some good information from Fred C. Simmons' *Northeastern Loggers' Handbook* (1951).

Bear in mind that some of these historic illustrations do not reflect modern personal protective equipment, particularly hardhats and eye protection.

## Using an Ax Safely

Personal protective equipment that you need for ax work varies with the job. Always wear good, stout leather boots, at least 8-inches high. Always wear safety glasses or goggles for eye protection. Hard hats are needed when there is any chance of being struck by something overhead. Hard hats are a must for tree-felling operations.

Some people wear gloves when using an ax, some don't. Gloves are a good idea for splitting firewood, where you are handling many pieces of splintered wood. Leather gloves are always required while sharpening an ax. For chopping, use your judgment. If leather gloves protect your hands and help give you a good grip on the handle, wear them. I personally don't wear gloves most of the time because I get a better purchase on the ax handle without them. The last thing I want to happen is for the ax to fly out of my hands on a swing. Then the person next to me really will need that hard hat!

**I**t's always a good idea to complete a job hazard analysis that identifies the safety concerns of the ax work you will be doing. In the Forest Service, a job hazard analysis is required. You must also describe the safety gear and procedures you need to follow to do the job safely. The job hazard analysis can save your life. Do it!



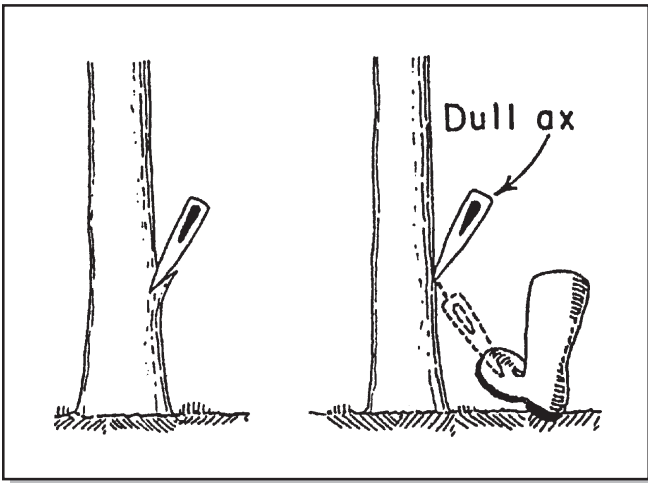


Figure 74—A dull ax or one that is too blunt is more likely to glance off dangerously than it is to cut (drawing from the *Northeastern Loggers' Handbook*).

Always carry your sheathed single-bit ax at its point of balance near its head with the edge pointing down. The ax should be on your downhill side if you are walking on a slope. If you fall or trip, toss the ax away from you. Carry a double-bit ax at your side. Carrying an ax on your shoulder is asking for trouble, especially in the woods or on rough trails. Don't do it.

Keep track of your ax. Be careful where and how you lay it down, and remember where it is. If you must leave your ax unsheathed, lay it flat with the edge toward a solid object like a log or a wall (Figure 75). Serious accidents are caused by stumbling over or falling on a carelessly placed ax.

For temporary safe storage, stick a single-bit ax in a log or a stump. Never lay it down flat out in the open. Never lean it up against a tree, a wall, or any other object where the edge is exposed. Don't leave it stuck for long in a block of wood because it will rust. A double-bit ax should never be stuck in a log with one edge sticking out. Place your double-bit ax underneath a log lying flat or put one bit into a small piece of wood and then stick the other bit into a horizontal log. A sheath is better than any of these methods.

Here are a few more pointers on ax work:

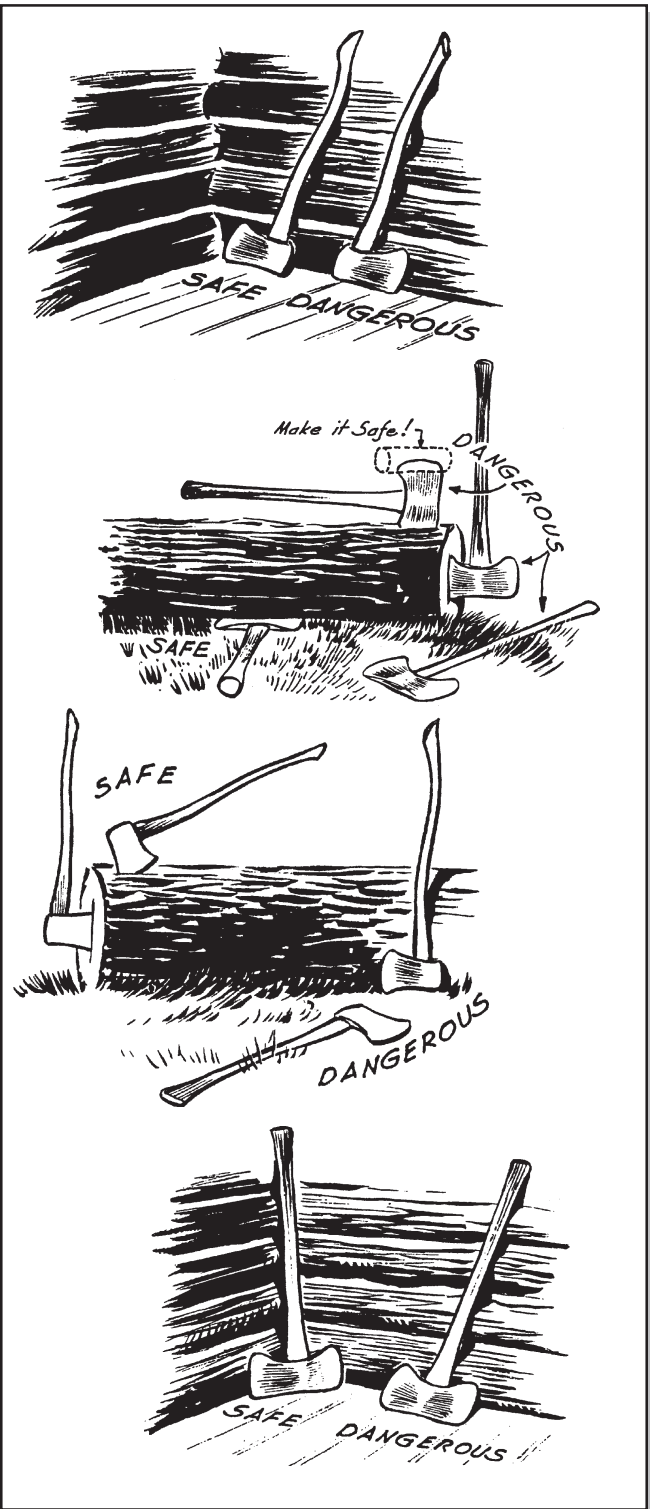


Figure 75—These methods may work, but it's better to keep a protective sheath on your ax (drawings by Frederic H. Kock).





- Do not chop directly through a knot if you can chop around it or chop the knot out. Knots often are very hard and can chip your ax or adz.
- Never strike the ground with your ax. If you need to cut roots, use a grubbing tool like a Pulaski or grub hoe. If you have to use an ax, use a “grubbing” ax that you don’t care about abusing.
- Never try to drive a stake or wedge with the flat side of your double-bit ax. It is almost sure to crack the eye.
- Never use the poll of a single-bit ax for pounding steel wedges. The poll is there for counter balance to the bit. It is not there for pounding! The poll is not tempered properly to pound and will become deformed or chips of steel may fly off. A single-bit ax can be safely used to pound wooden or plastic wedges—that is all!
- The ax head is brittle at extremely cold temperatures. It is likely to chip unless it is warmed before using. One way to warm up your ax is to place it (sheathed of course) under your armpit, for a few minutes. Or warm it between your hands. If you don’t want to share some of your body heat with your ax (which by now should be considered a family member), chop very slowly for at least 2 minutes in order to warm the ax up in the wood.

## Chopping Technique

Chopping is an art. Start out loose and relaxed. Hold the ax with one hand fixed just above the swell at the end of the handle. On the up-stroke, the other hand slides up the handle close to the head. On the down-stroke, it slides back down the handle. At the point of impact, it is close to the lower hand. Each blow lands exactly where it is intended, with the proper force, and at the proper angle. There is no shock to the hands or shoulders. One corner of the ax blade should always be free of the wood, so that a slight twist

brings out the chip and releases the bit without undue strain.

**Grip**—On an ax that is hung properly to fit you, place your left hand about 1 or 2 inches from the butt end of the handle or helve. Place your right hand about three-fourths of the way up the handle. This is the proper hold for a right-handed person (Figure 76).

**Forehand Swing**—This swing is used to cut the right side of a notch. These instructions are for

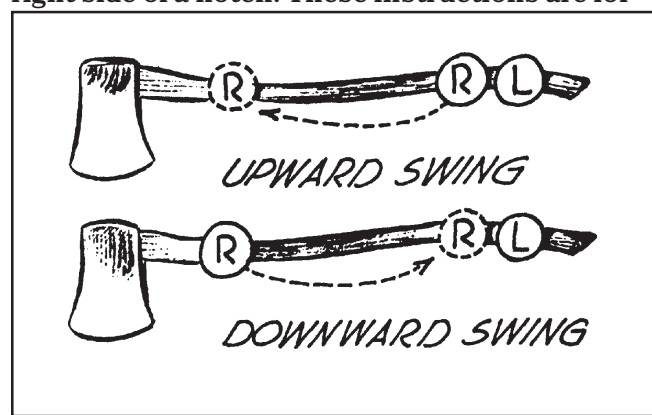


Figure 76—The proper ax hold for a right-handed person (drawing by Frederic H. Kock).

right-handed choppers. Raise the ax over your right shoulder, your hands in the starting position (Figure 77). Swing the ax down on the log with a very natural swing motion, your right hand sliding down the handle toward your left hand at the bottom of the handle. You will end this motion with both hands at the end of the handle when the ax strikes the wood. Do not drive the ax straight into the wood, but instead cut on an angle about 45° to 50° from the edge of the log (Figure 78). Raise the ax again, slide the right hand up about three-fourths of the way on the handle and start your next swing. Continue this motion for the forehand swing. Your left hand never leaves the end of the handle.



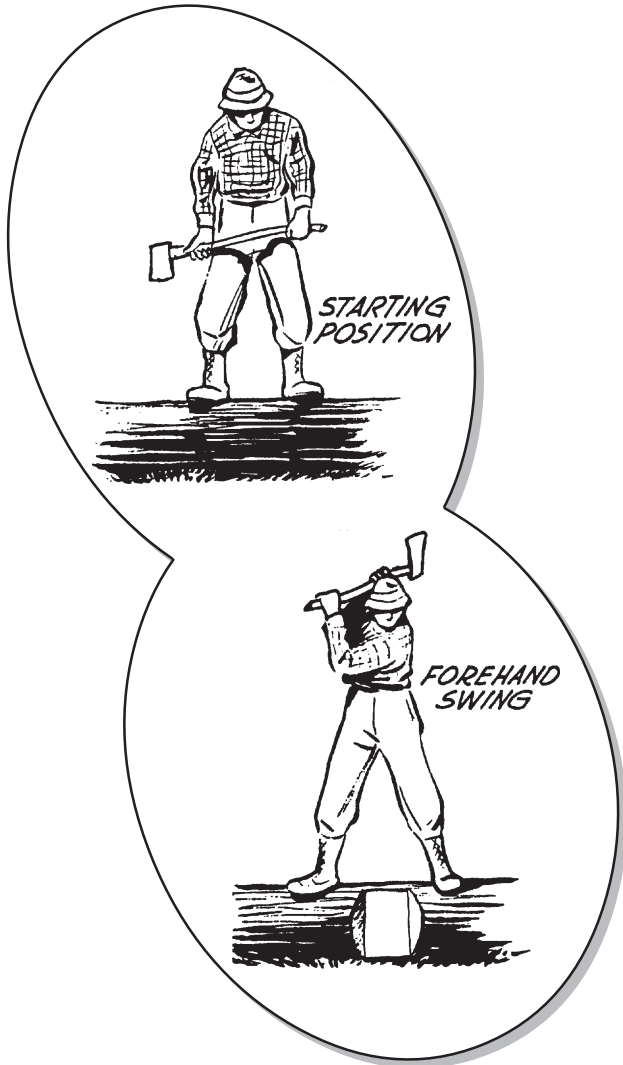


Figure 77—Forehand swing (drawings by Frederic H. Kock).

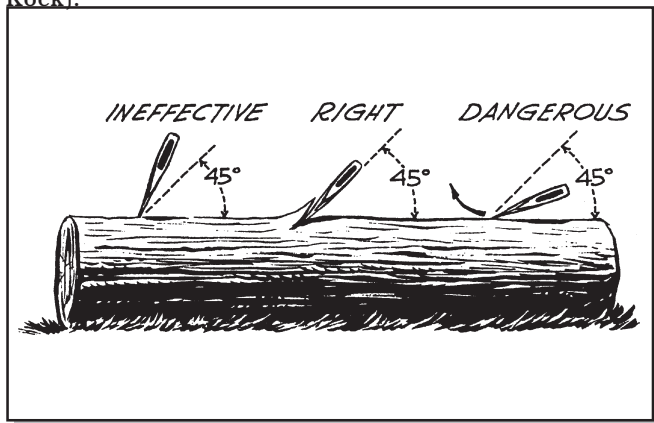


Figure 78—Cut at a 45° angle to be most effective (drawing by Frederic H. Kock).

**Backhand Swing**—The backhand swing is used to cut the left side of the notch (Figure 79). Bring the ax over the right shoulder as in the forehand swing, but shift your body well to the left so that the ax comes down more in line with the left side of the notch. This backhand swing is somewhat more difficult to master gracefully. Proper ax use always includes these two motions, the forehand swing and the backhand swing, always over the right shoulder for right-handed choppers. Changing hand positions instead of using or developing the back swing technique is not considered acceptable ax use.

Accuracy is the only thing that matters when using the force

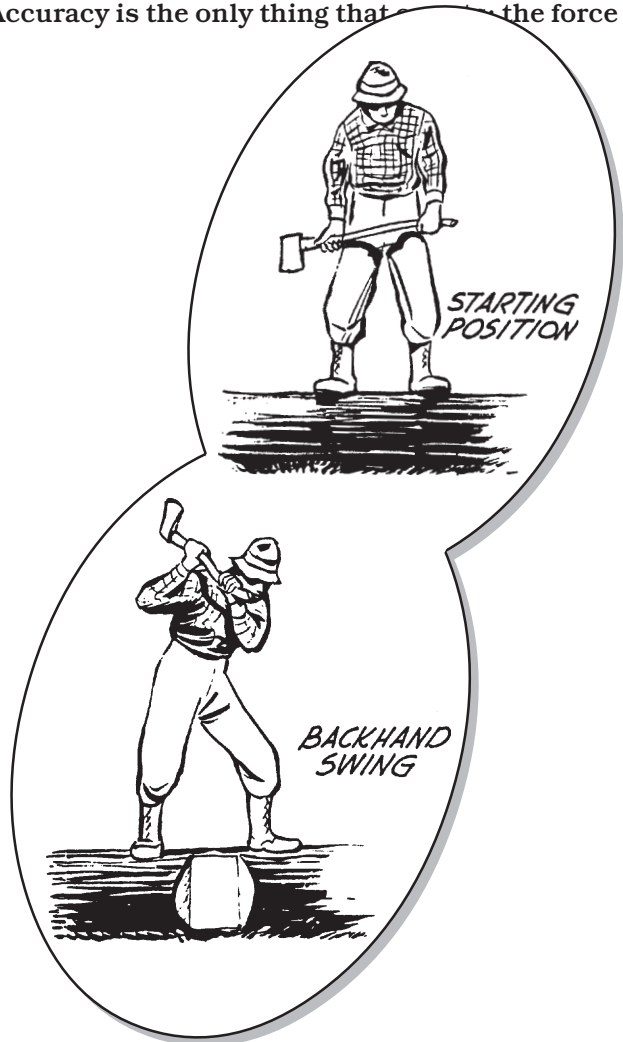


Figure 79—Backhand swing (drawings by Frederic H. Kock).

of the swing is not nearly as important as its placement. Chop with a series of strokes: the top, the bottom, and then the middle (Figure 80). If you chop in that order (top, bottom, middle) with both the forehand swing and the backhand swing, the chip will fly out after your last cut. On your last cut in the middle on the backhand swing, you should give a slight twist to the ax as you sink it into the wood to pop the chip out. Swing with a natural rhythmic and unforced motion. Always watch your aim. Leaving one edge of your ax blade exposed will help ensure it doesn't get stuck in the log.

It is best to confine yourself to one grip and do all the chopping either right- or left-handed,

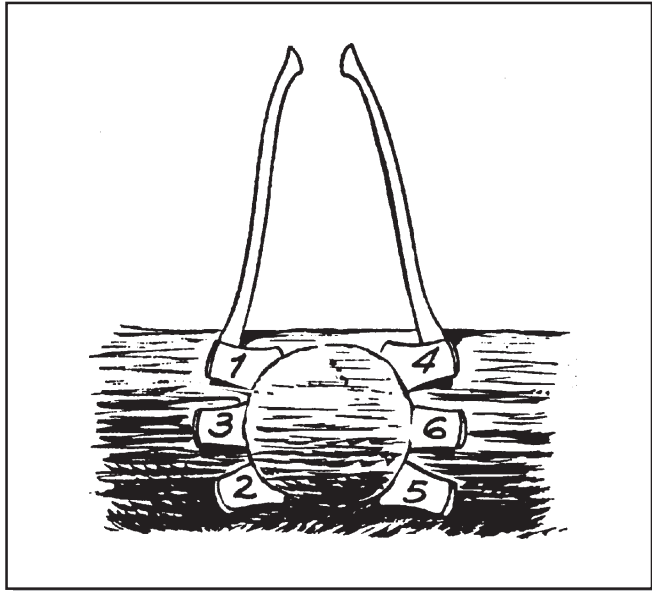


Figure 80—Sequence of strokes for most efficient chopping (drawing by Frederic H. Kock).

whichever is your natural swing. In the long run, it is important to learn to chop well both right-handed and left-handed. Being ambidextrous can save a chopper a lot of trouble in everyday work in the woods, particularly in limbing.

Other grips besides the full-swing chopping grip are used for specific tasks (Figure 81). For careful and delicate work, such as sharpening stakes, notching house logs, or some limbing, use a two-handed choked grip, with both hands grasping the ax near the center of the handle. For cutting

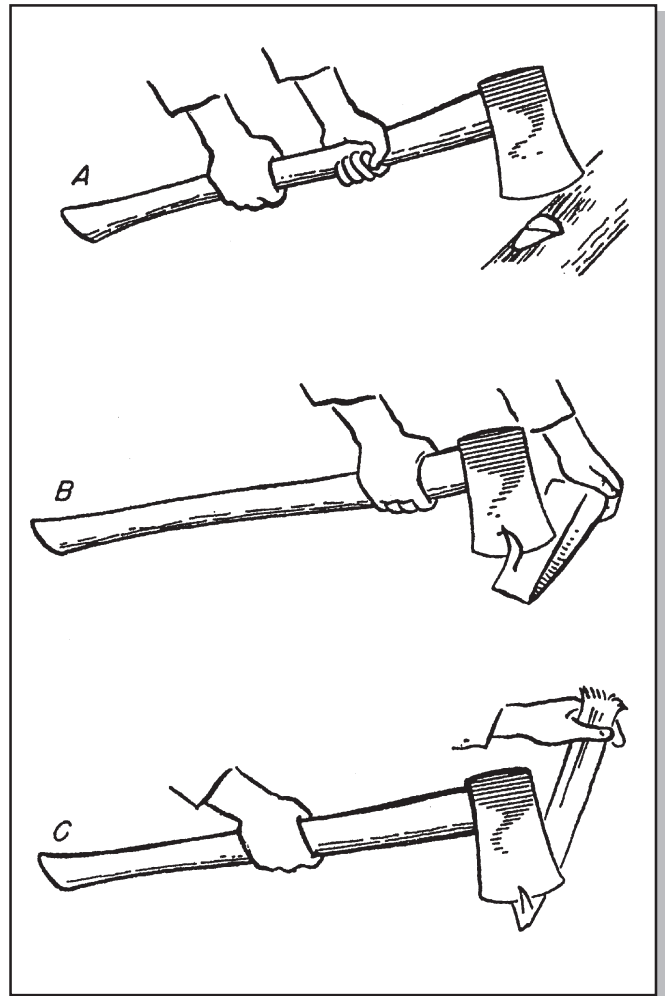


Figure 81—Three ways of gripping the ax for precise strokes: a) two-handed choked grip; b) one-handed choked grip and; c) one-handed full swing (drawings from the *Northeastern Loggers Handbook*).

brush or sharpening wooden wedges, use a one-handed grip at the ax's point of balance near the head. For splitting wood, cutting saplings, or sharpening stakes by yourself, use a one-handed grip, with your hand about halfway down the handle. Your spare hand should be nowhere near the ax blade during these operations!



## Felling Trees

**F**elling is probably the most dangerous and difficult job in the woods. The USDA Forest Service has long required specialized training and certification before any of its employees are allowed to cut standing trees. This training is required whether chain saws, crosscut saws, or axes are used to fell the trees.

This description of felling with an ax is meant only to give the reader a generalized idea of the felling procedure. It should not be construed as a training guide. A faller needs to judge many variables—some deadly if misjudged—before attempting to cut down a tree. The information presented here is just a guide to help prevent some common mistakes. It focuses on ax techniques rather than felling techniques.

Never start chopping until you are sure there are no branches or brush in the way. An ax deflected by a small branch or twig can cause a serious accident. Be sure your fellow workers are in the clear.

Decide the direction in which you want the tree to fall, ideally with the natural lean of the tree. If not, you may have to use special techniques and equipment to offset the lean, techniques a novice should not try. Your ax can serve as a plumb to determine the tree's natural lean. To do so, hold the ax in your hand above your head at arm's length (Figure 82). Grip the very end of the handle with the ax head down. Use the ax as a plumb to sight around the tree from different positions as you walk a circle around the tree. Be sure to take into account the crown mass, which side the branches are on, and whether there is more weight on one side or the other.

Consider wind direction. A slight breeze on the ground can be more powerful at the top of a 60- to 100-foot tree. Wind can change the direction of fall with unpredictable results. Heed the warning

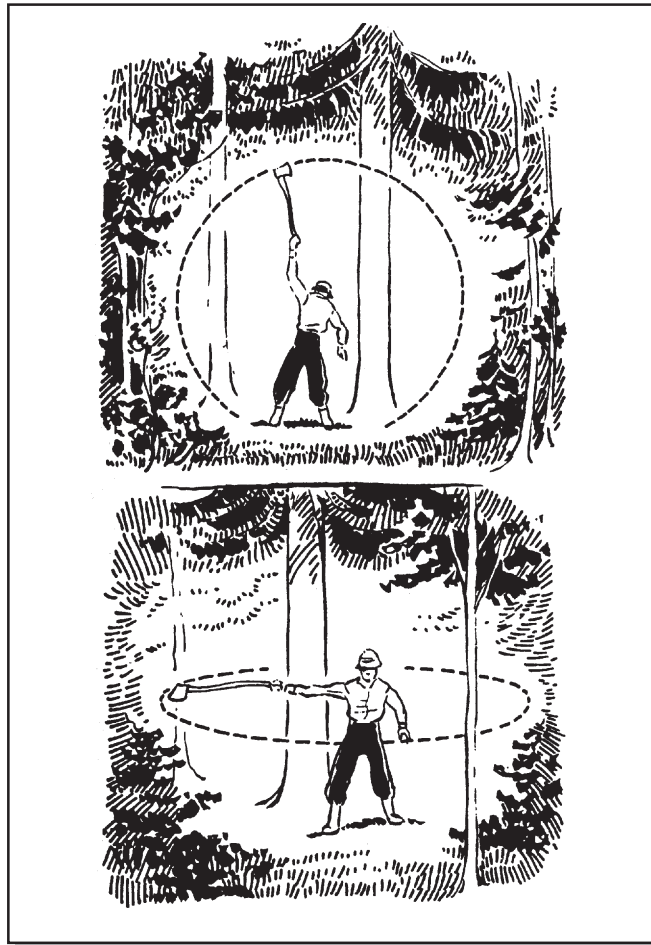


Figure 82—Using an ax as a plumb. A hard hat is also required here (drawing by Frederic H. Kock).

of an old country-western song by Sonny James: *Don't Cut Timber on a Windy Day*. Decide the direction you will need to move the log after it is down on the ground. Try to drop the tree in a clearing, if possible.

After you have determined where the tree is going to fall, gently swing your ax handle fully extended over your head in a 360° arc to make sure there are no obstructions (Figure 83). Walk around the tree at arm's length with the ax fully extended to make sure that there are no branches within this circumference. Clear the underbrush for an escape path at about a 45° angle to the direction of the planned tree fall. The route should be clear of all vines, branches, and rocks—anything that you might trip over. Never stand directly behind the tree as it falls or during your escape. If the tree kicks back, or if the tree slabs and splits, the back portion will kick straight back.

“Widow makers” are another danger. These are usually dead branches in the tree you're felling or in neighboring trees that might be knocked down by the tree you are cutting. You should always wear personal protective gear during these



Figures 83—Clear an area completely around the tree before starting to chop (drawings by Frederic H. Kock).

operations. Hard hats and safety glasses are a must.

Make sure your footing is secure and stable. Chop only when you are well clear of other people. Stand with your weight evenly distributed with both feet planted about shoulder width apart. Check the distance to stand from the cut before you start to swing. Start swinging with a very gentle easy motion in order to gauge your distance and your power stroke.

The first cut will be the front notch or the undercut in the direction of the planned fall (Figure 84). This notch should be about one-third to one-half of the diameter of the tree when felling strictly with an ax. If a crosscut saw is

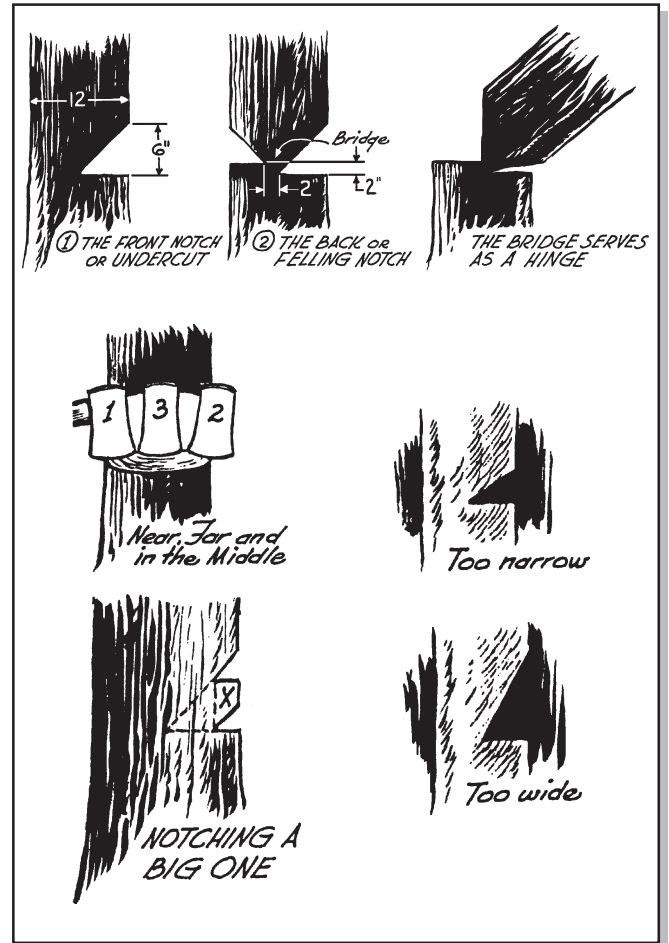


Figure 84—Notching a tree to determine the direction of fall (drawings by Frederic H. Kock).

used in combination with the ax, the front notch should be no more than one-third of the diameter of the tree.

Use your ax as a sight guide to determine if the notch is in the proper direction of the fall (Figure 85). A double-bit ax is best for this purpose as it makes a perfect T-square. Place the head of the double-bit ax in the front notch that you have just cut, with the handle pointing directly in the planned direction of the fall. If the handle does not point in the planned direction of the fall, you must re-chop the notch until the handle points in the right direction.



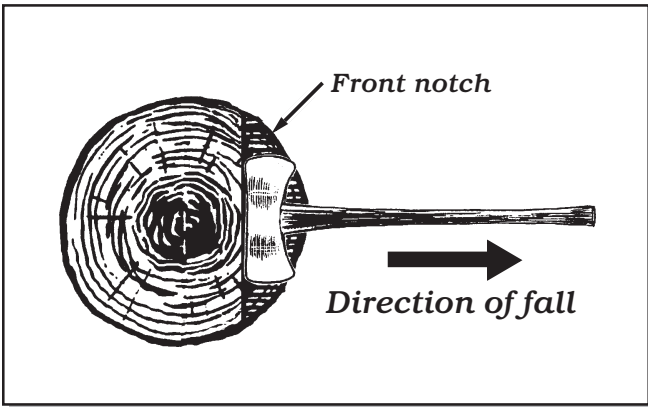


Figure 85—Using a double-bit ax as a T-square to indicate the direction of fall.

Now begin the back cut, or the final felling cut, on the opposite side of your front notch. The back notch should be a minimum of 2 inches higher on the stump than the front notch. The back notch is cut to within about 2 inches of the tip of the V on your front notch (Figure 86). Never cut completely through the back notch to the front notch.

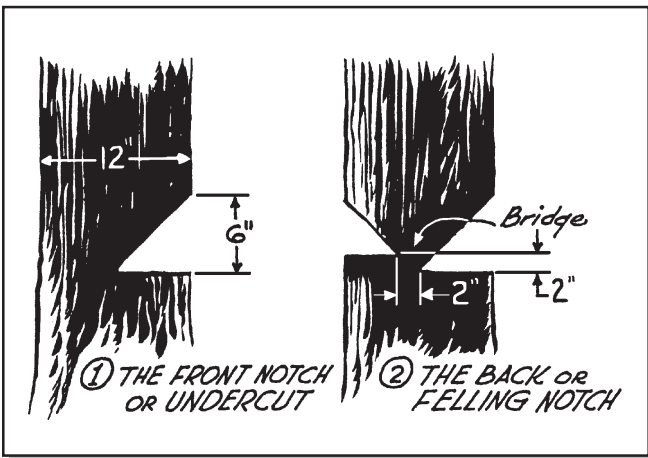


Figure 86—Back notch or the final felling cut.

Remember the rule when placing your cuts to create a notch—near, far, and middle to remove each chip. Always place the front notch and the back notch as low on the tree as possible while standing safely and comfortably. As the back notch gets deeper, closing in on the 2 remaining inches of hinge wood, keep glancing toward the top of the tree. The tree will start moving there

first, allowing you to detect whether the tree is going to fall in the planned direction. A gust of wind blowing opposite the planned direction of fall can get you into serious trouble at this point.

**C**utting through the hinge wood is the single most dangerous thing a novice faller can do. Never cut through the hinge wood! If you do, you will have absolutely no control over the direction the tree will fall, and it could very well fall on you.

When the top of the tree starts to move in the direction of fall, move a few yards back away from the tree at an angle (Figure 87); never move directly behind the tree or in front of the fall! Keep your eye on the top of the tree while making your escape. You should get as far from the tree as possible. Keep your eye on the tree long enough to make sure not only of its direction of fall, but to look for widow makers that can be thrown back in your direction. As the tree is going down, continue to look overhead. You are only safe once the tree and broken limbs are on the ground.

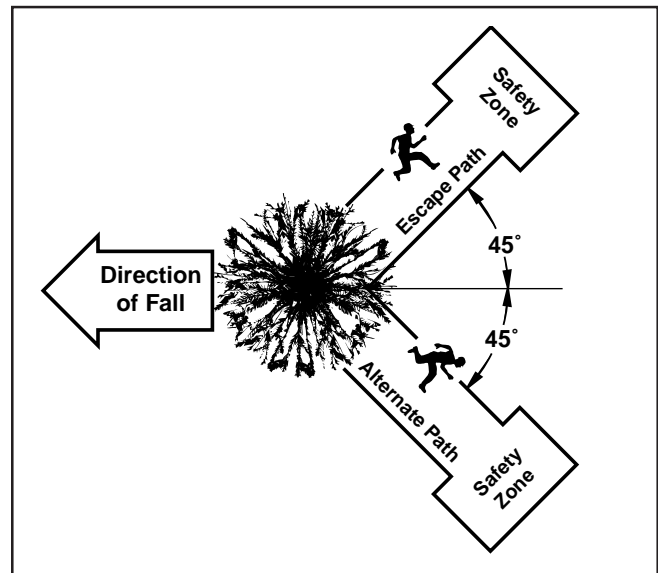


Figure 87—Plan and clear escape routes at an angle away from the planned direction of fall.

**W**hen you use an ax for both the front and back notches instead of using a crosscut saw for the back notch, you cannot use a wedge to secure the direction of fall. This is one disadvantage of using an ax instead of a saw for the back notch.

## Limbing

After the tree is on the ground, the next step is removing its branches, called limbing. Start at the butt of the log and work toward the top, cutting on the underside of the branches (Figure 88). Always limb from the opposite side of the log with the log separating you from the ax. Limbing is a dangerous operation because of the chance of glancing blows (Figure 89) when the ax does not dig into the wood.

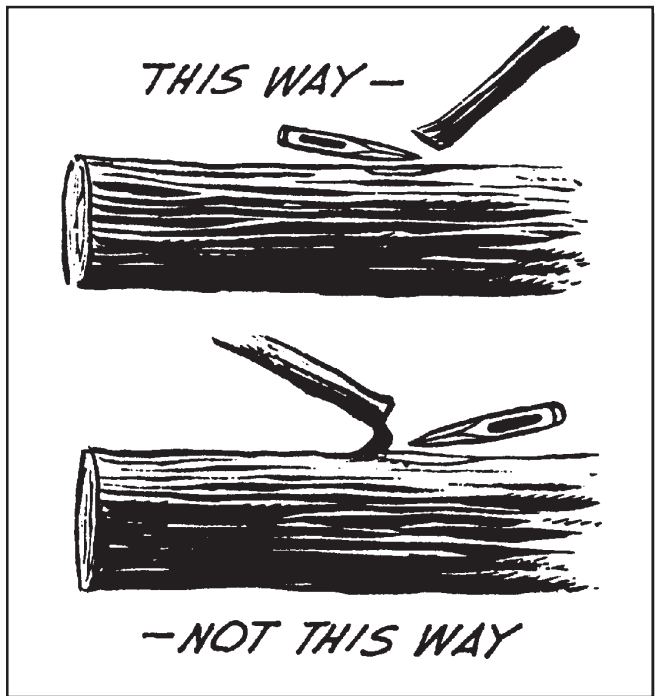


Figure 88—Cut the underside of the branch when lopping branches (drawings by Frederic H. Kock).

**BRANCH ON THE FAR SIDE**



**NEVER ON THE NEAR SIDE**



**NEVER STRADDLE THE LOG**



Figures 89—Guidelines for limbing (drawing by Frederic H. Kock).

You need to pay attention to branches that are under compression, those that bear the weight of the log. When the limb is cut, the limb may spring free, striking you. The log can also roll.

Limbing is like other chopping in most ways. The same grips on the ax handle are used and the swing is the same. Much of the ax work, however, is performed in constricted, awkward positions. Some branches are large, others small. You need good judgment to place the right amount of force behind each swing of the ax.

The danger of accidents from an ax that has been deflected by branches is much greater than with clear chopping. One important precaution is to clear interfering branches



before attempting to chop a large limb. If the log is so large that you cannot reach over it to limb, chop the top branches off first. Stand on top of the tree trunk to chop the side branches. Cut each limb flush with the trunk; leave no stobs or pig ears.

The inexperienced chopper should do very little limbing while standing on the log. Experienced choppers with sure control of the ax will be able to work safely in the more hazardous positions.

**A** good suggestion from Ian Barlow, trails and wilderness expert on the Nez Perce National Forest:

*No matter how hard you try to avoid it, sometimes you have to limb on the same side of the log that you are standing on. When that happens, a good rule of thumb is to never let your ax handle or your ax head drop below the level of your hands while you're chopping. If you never let your ax head break a plane that's parallel with the ground, you can't cut your feet.*

For large limbs, particularly on hardwoods, it is often necessary to cut a notch similar to that used in cutting down a tree (Figure 90). Cut from the lower side of the limb, as always, and keep the bottom of the notch even with the trunk

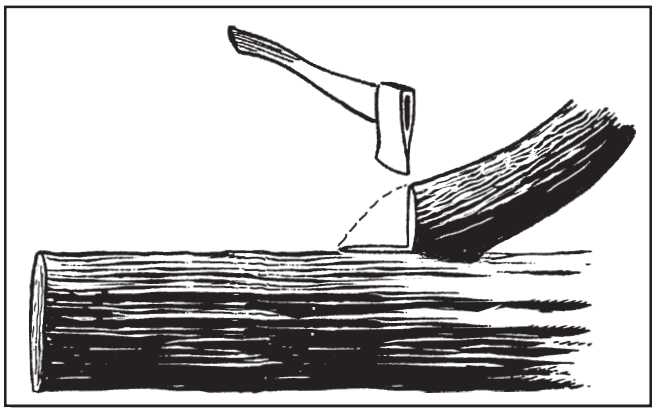


Figure 90—Cutting off a large limb.

surface. The vertical side of the notch should slope somewhat with the angle of the limb. Often a larger notch is easier to cut than a smaller one. The downward cut is made with the grain of the wood and not directly across it.

A word should be said about hemlock knots. These knots are very hard, especially on dead limbs. It is sometimes better to break off small limbs with the poll of the ax than to try to chop them. It is easy to take a huge nick out of the ax bit by swinging too hard at right angles to a hemlock limb. This is more likely to happen in cold weather, when the ax is more brittle. In such cases, warm the ax bit before using it on such limbs. If possible, use an ax with a blunter taper than you would for ordinary chopping. As a final precaution, chop lightly at an angle to, or with, the grain, and do not attempt to twist out the chips.

## Cutting Pinned-Down Saplings

A dangerous job that goes along with limbing is cutting off bowed-over saplings, whose tops have been pinned down by the fallen tree. Never cut them by giving either the top or the butt a whack with the ax from the outside. They can spring out like a catapult, with a force that can easily break a jaw or arm. The trick is to cut the bowed-over tree from the inside. If this is impossible, give the strained fibers on the outside a light touch with the ax to partially release the strain before fully severing the sapling.

## Bucking

Bucking means cutting a tree into log lengths or firewood bolts once it is on the ground. Often it is also necessary to buck logs that have fallen across trails. Most bucking is done with the saw, but there is nothing wrong with using an ax for this job. A good chopper can often buck a log in the same time it takes to set up a crosscut saw



and use it to cut a log.

The beginning chopper should stand on the ground to the side of the log. Make sure you have firm footing. Take a wide stance and chop between your feet, turning your body in the direction of the ax stroke as you cut first one side of the notch, then the other. Again, keeping the handle parallel with the ground will prevent foot injuries.

For an experienced ax user, the proper position for bucking is to stand directly on top of the log and chop halfway through one side. Turn around and chop halfway through the other side to finish the cut. These two V-notches will meet right in the middle of the log (Figure 91).

On logs that are small enough to be rolled over,

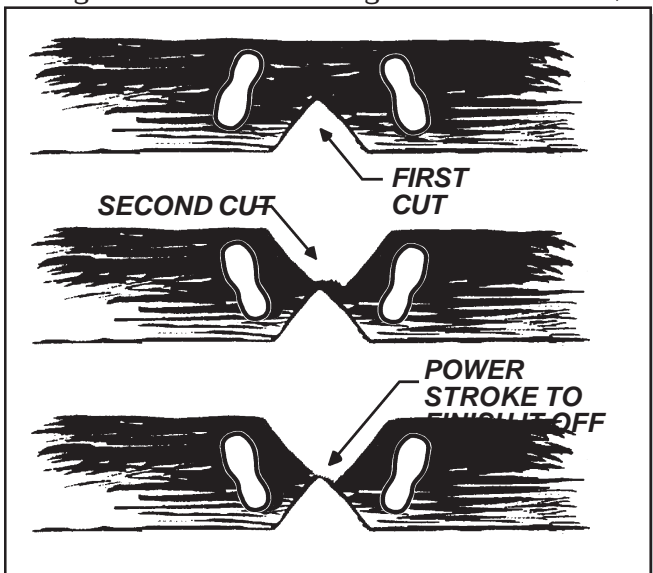


Figure 91—Top view of the sequence of cuts made by an experienced right-handed chopper standing on top of the log. The final power stroke is offset slightly.

you can achieve the same economy without standing on the log. Stand on the ground and chop a V-notch on the top, then roll the log over and chop a V-notch on the bottom.

Often it is necessary to chop a large log while standing on the ground. You must make a very large V-notch to chop all the way through from just one side. You also risk hitting your cutting

edge on a rock as you finish the cut.

How wide should you cut your V-notch? The

The advantages of chopping two V-notches in a log instead of one large V-notch is simply a matter of ease of chopping. Chopping two smaller V-notches is easier and takes less time than cutting one large notch.

most common mistake is to make the V-notch too small (Figure 92). This pinches the middle of the V-notch before you reach the center of the log. You will quickly find that chips will not clear from a notch that is too wide. If a very large log is bucked, you need to make your notch narrow and then widen it out; the chips won't clear if you start the notch much wider than 10 to 12 inches.

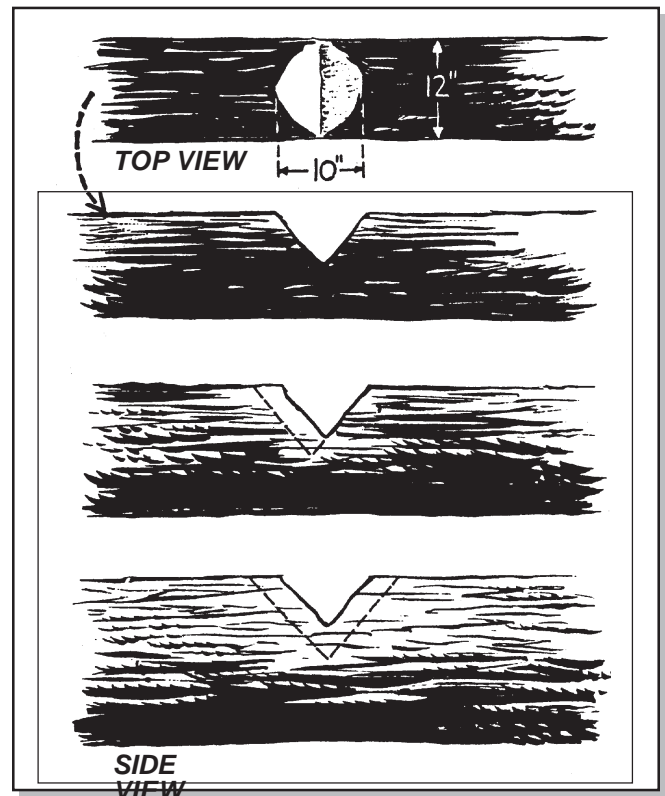


Figure 92—Size the notch to close halfway through the log if you can chop both sides of the log. If you can only cut on one side, the notch will have to be much larger (drawings by Frederic H. Kock).

On a large log you increase the size of the notch by chopping out one side. Always remember your high, low, and middle technique for placing ax blows. Make three forehand swings, high, low, and middle, followed by three backhand swings. If you are standing on the log, your first swing should strike high at the top of the log; the second at the bottom of log; and the third right in the middle. If you follow any other sequence, the ax will stick in the wood. The last stroke, stroke number six, throws the chip on the ground (Figure 80).

**G**ive a slight twist to the ax on this last chip-removal stroke. This twist will help bust the chips out and keep the ax from sticking in the log.

## Splitting

The wood to be split is cut into stove lengths that can be anywhere from 12 to 24 inches long. Stand the wood on end, either on the ground or on a chopping block, if the wood has been cut straight with a chain saw or crosscut saw. If the ends are uneven, the wood needs to be placed in a crotch of a downed tree to hold it upright (Figure 93).

You should have a designated splitting ax. Its blade should have a much steeper angle than a felling and bucking ax. Take advantage of existing cracks or checks in the wood to help direct your first blow, because the first split is generally the most difficult. Swing straight down toward the top of the block. Use your body weight, with your knees snapping into position just as you hit the block of wood. Give the ax handle a slight twist just as the bit hits the block (Figure 94). This throws the block of wood apart and prevents the ax from sticking. The real secret of splitting wood with an ax is in this little twist right at the end of the stroke.

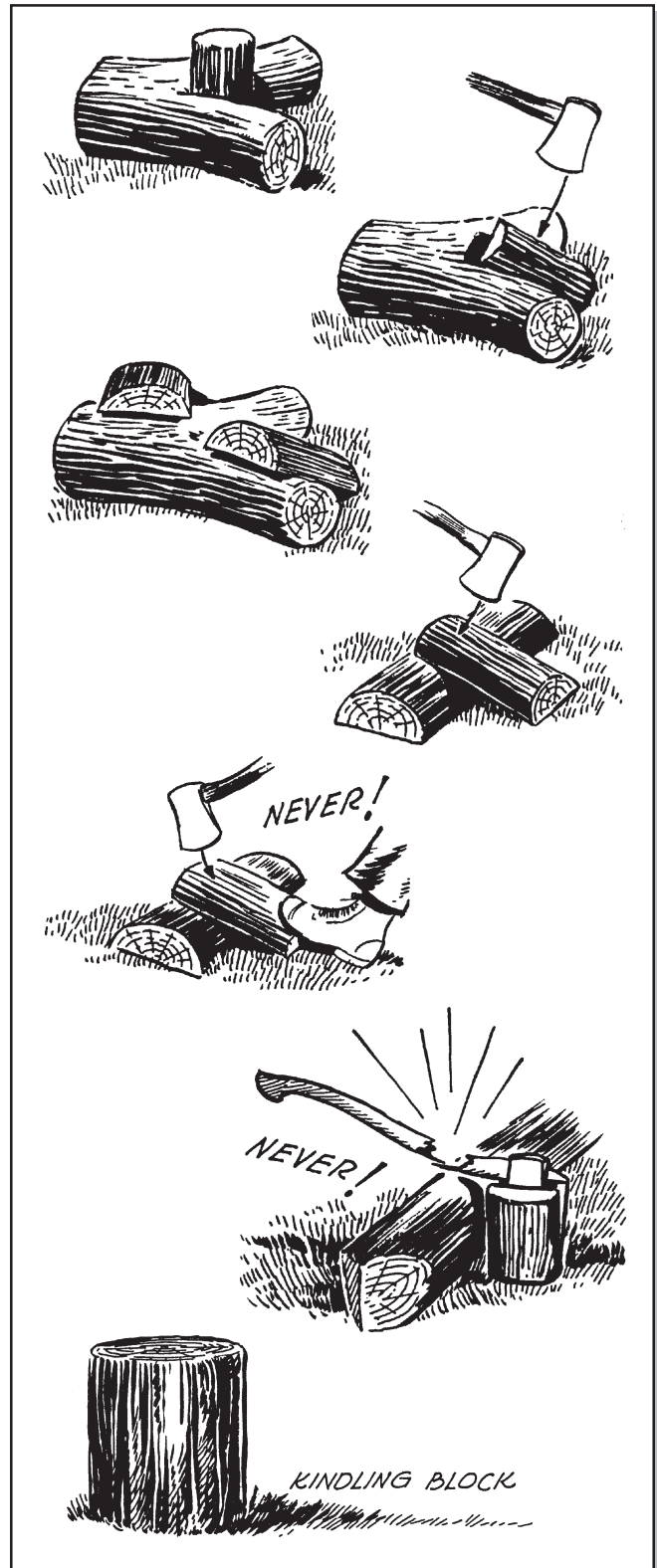


Figure 93—Safe and unsafe techniques for splitting wood (drawings by Frederic H. Kock).

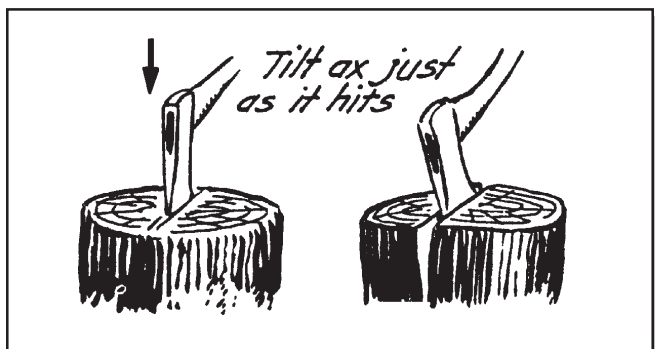


Figure 94—Twist the ax head as it enters the wood to keep it from sticking (drawing by Frederic H. Kock).

On a knotty, gnarly block of wood you'll need to start your split from the outside edges and slab off the sides. Inevitably, your ax will become stuck in the block you are trying to split. The best way to remove it without damaging the ax is to rap the end of the handle sharply downward with the palm of your hand without holding the handle.

## Hewing

Hewing is shaping a log with an ax or an adz. The primary tools are the single-bit ax and the hewing or broad ax. The single-bit ax is used for scoring, a process of chopping cuts perpendicular to the length of the log down to a chalk line marked on the log. This line marks the edge where you want the flat, hewn surface.

Follow the scoring process with broad ax hewing. An adz is sometimes used for the final dressing of the hewn log. Hewing can convert a round log from the woods into a square timber or a partially squared timber called a cant. Hewing doesn't work well on dry logs, so hew green, freshly cut logs. Here is a summary of the steps to follow:

1. Remove the bark from the log using a drawknife (Figure 95), bark spud (Figure 96), or possibly your single-bit ax. Place the log crossways on two other short sections of log that have a V-notch chopped in them to cradle the log. The log to be hewn should be

placed in these V-notched cross sections, called yokes, at a height that is comfortable to hew. The position should be about knee high or a little bit higher.

Place wood chips, a wood slab, or an old board on the ground underneath the log to



Figure 95—Removing bark from a green log with a drawknife.



Figure 96—Using a bark spud.

keep the broad ax from digging into dirt and rocks. Clamp the log to the yokes with log dogs, big iron staples driven into both the yoke and the log at both ends (Figure 97). This keeps the log from moving from its proper position.



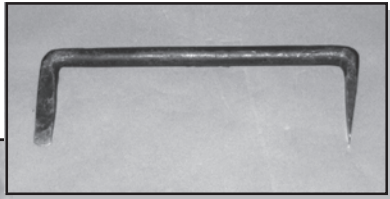


Figure 97—Use a log dog to secure the log to the yoke.

- Using a level or a plumb bob (Figure 98), scribe a vertical line on the small end of the log to mark the depth to which you want to hew. Then, to make sure the log is large

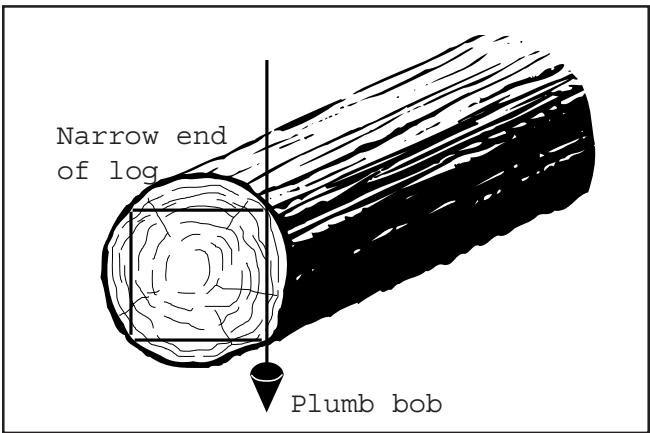


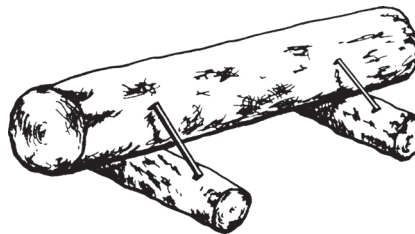
Figure 98—Lay out the dimensions of the beam on the small end on the log.

enough, measure out the final end dimensions of the cant or beam you wish to create. Scribe this layout on the small end of the log first, because it is more difficult to fit it there than on the large end of the log.

- Now move to the large or butt end of the log and repeat the process of scribing the end dimensions of the beam or cant.
- Snap a chalk line from the upper corner of the layout on one end to the corresponding corner on the other end (Figure 99). It is easier to do if you first cut a notch in the log with your pocket knife immediately above the scribed vertical line. Drive a nail into the vertical line just deep enough to hold one end of the chalk line. Run the chalk line up through the notch and along the length of the log (Figure 100). Then, holding the line tightly at the other end, snap the line by raising it straight up and letting it go.
- Next, score the log. To start scoring with your single-bit ax, stand on top of the log.



Figure 99—The chalk line will mark the top side of the hewn surface.



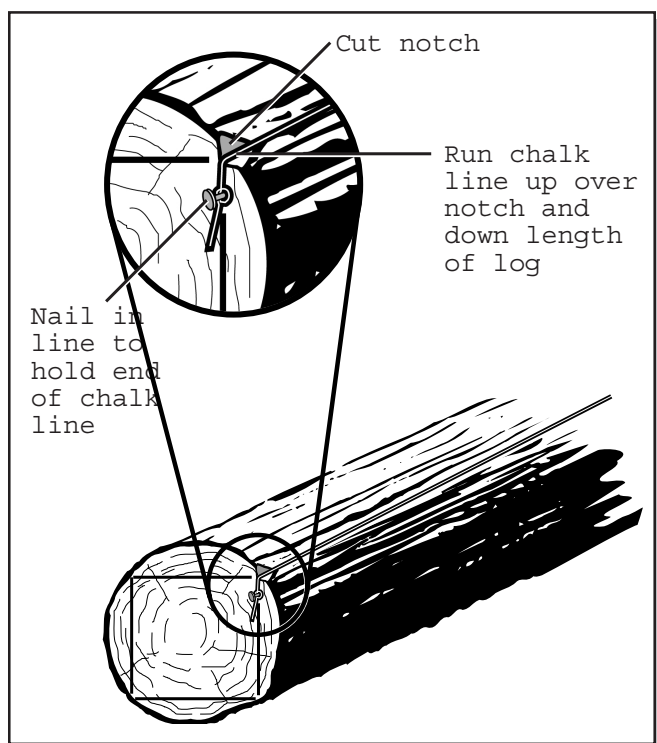


Figure 100—Here's a way to secure one end of the chalk line while you move to the other end.

Chop to the depth of the chalk line in the center, or for a large-diameter log, take chops high, low, and in the middle. Do not burst (clear) the chips. Each of these swings is done with the forehand swing only. This process is called slash scoring. It is the most common method of scoring. The slashes are placed 3 to 4 inches apart down the length of the log.

On a large log, scoring is easier using a method called “juggling” (Figure 101). In juggling, you score the log by chopping a series of shallow V-notches to the depth of the chalk line. To do this, stand on top of the log and cut with both the forehand swing and the backhand swing. Then, still working from the top of the log with your single-bit ax, chop parallel to the log with the grain to split off the chips between the V-notches (spaced 10 to 12 inches apart, Figure 102).

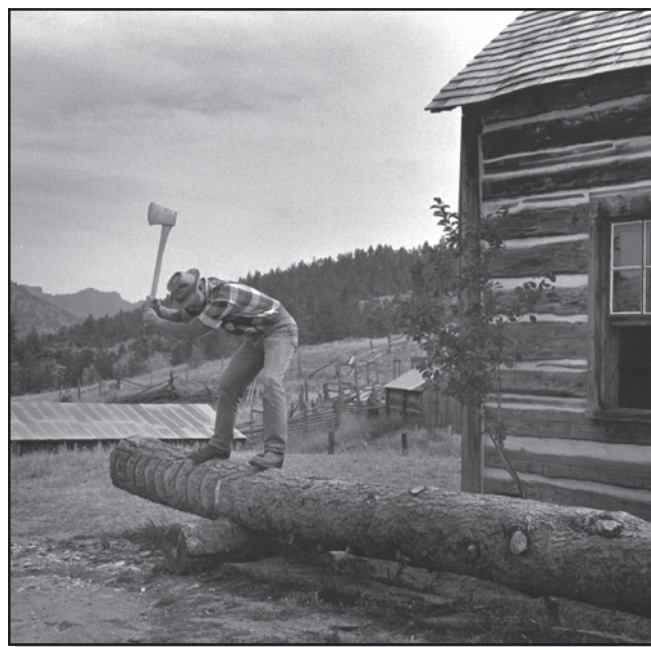


Figure 101—In the scoring technique called juggling, you cut a shallow V-notch down to the depth of the chalk line. Slash scoring is a different technique that doesn't involve cutting a V-notch.

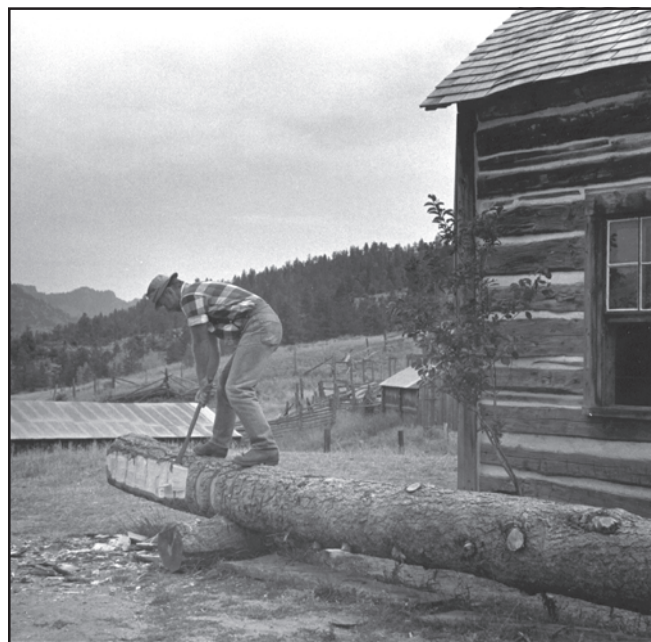


Figure 102—Finish the juggling process by removing the excess wood between V-notches with a single-bit ax.





6. Hewing with the broad ax is the next step (Figure 103). In a right-handed swing, your left hand should be on the end of the broad ax handle, with your right hand holding the handle near the ax head. Standing on the ground, spread your legs apart so they are out of harm's way, and swing straight down toward the ground. Follow the chalk line, breaking the remaining wood between the scoring slashes, or between the V-notches left from juggling.



Figure 103—Hew down to the chalk line, removing the excess wood left after scoring.

If a chip of wood gets stuck to the ax bit, which often happens while hewing, stop and remove the chip carefully from the ax blade. A chip stuck to the bit of the ax will guarantee a glancing blow when you begin your next cut.

After scoring and hewing the first side of the log, move the log dogs one at a time so the log does not shift off plumb. The opposite side of the log is then freed up but is still held in a plumb position. Repeat the scoring and hewing process on the opposite side of the log. At this point the log is flat on two sides.

Generally only two sides of the log were hewn in cabin building, the exterior and the interior walls. If you want to hew all four sides, you will need to rotate the log 90° and repeat the process on the remaining two sides.

7. Use an adz to give a more finished appearance to the hewn log. The traditional method of using the adz is to roll the log 90° so the hewn side is face up. Stand on top of the hewn face and cut directly toward your toes. As you might imagine, this can be a dangerous operation for someone who is unskilled. The adz needs to be razor sharp to cut well. The utmost concentration is needed to swing the adz with enough power for it to do its job but not enough to slice your toes (Figure 104). On small logs, you sometimes can straddle the log and swing the adz between your legs (Figure 105).

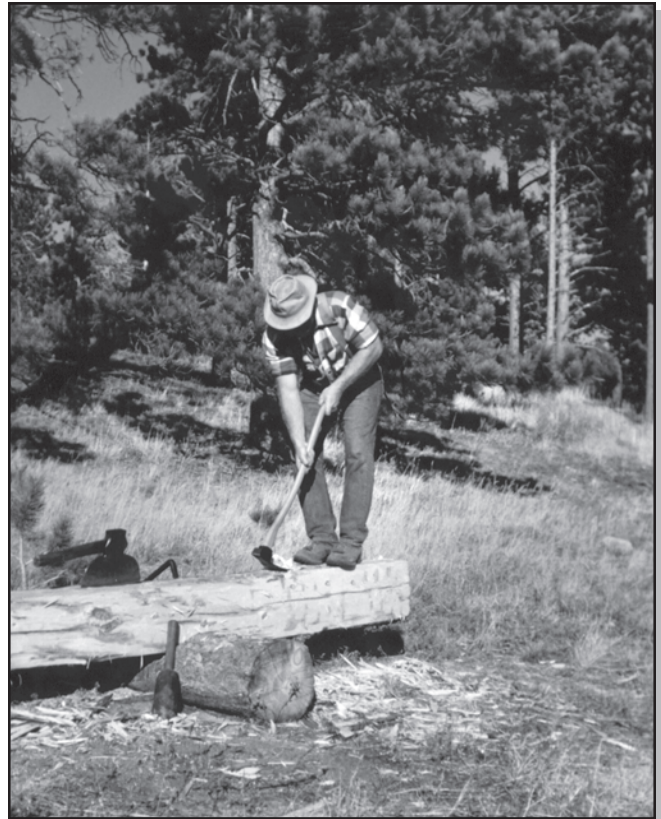


Figure 104—Adz work requires the utmost concentration to avoid cutting your feet.



Figure 105—You may be able to straddle a small log when using an adz (drawing by Frederic H. Kock).

**H**istoric log buildings often display the tooling marks of ax and adz work, best seen on the interior walls. It is often possible to tell if the hewer was right- or left-handed by the position of the scoring marks and the broad ax marks. There is also a great difference between the tooling marks left by a broad ax and those left by an adz.



# Using Axes





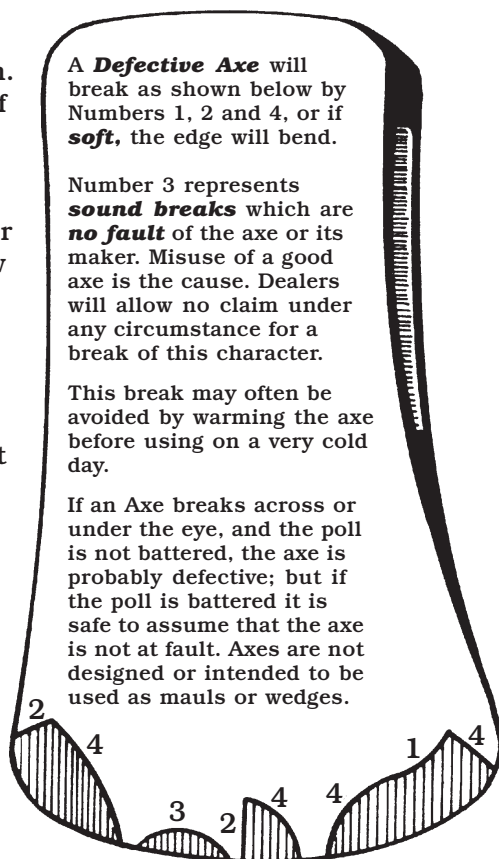
# Buying an Ax

## New and Used Axes

Acquiring a good ax is almost as difficult today as learning to use one properly. The majority of American ax manufacturers have gone out of business; only a few are left in the United States. A few ax companies in other countries, including Sweden, Australia, and New Zealand, still manufacture quality axes. I have found the steel and fit of imported Chinese axes to be of very poor quality. These are often sold as generic "no name" axes at discount outlets. Let the buyer beware.

Buying a quality used ax at a secondhand store, flea market, or farm auction may be your best bet. Most used axes are also abused axes, but about 1 out of 10 is still usable. The price is usually right. Used axes can often be picked up for half the cost of a new ax. Look not only at the ax's condition, but take the ax's manufacturer and its head pattern into consideration. The quality of steel and the tempering of old axes is often superior to that of new axes (Figure 106). The helve or the handle is not of any importance at this point. Shop only for the ax head and plan to rehang it to fit your needs.

### Manufactures



A **Defective Ax** will break as shown below by Numbers 1, 2 and 4, or if **soft**, the edge will bend.

Number 3 represents **sound breaks** which are **no fault** of the axe or its maker. Misuse of a good axe is the cause. Dealers will allow no claim under any circumstance for a break of this character.

This break may often be avoided by warming the axe before using on a very cold day.

If an Axe breaks across or under the eye, and the poll is not battered, the axe is probably defective; but if the poll is battered it is safe to assume that the axe is not at fault. Axes are not designed or intended to be used as mauls or wedges.

Figure 106—Telling if an ax is defective or abused (drawing courtesy of Snow & Nealley, Bangor, Maine).

**Ames/Woodings-Verona** manufactures quality striking tools, including axes and hatchets. Woodings-Verona is a division of the much larger Ames Company.

World Wide Web: <http://www.ames.com>

Ames Lawn and Garden Tools  
Box 1774  
Parkersburg, WV 26102  
Phone: (800) 624-2654 or (304) 424-3000  
Fax: (304) 424-3399

**Barco Industries, Inc.**, and sister company, Phoenix Forging Company, Inc., have a large line of striking tools, including axes and hatchets. These tools are marketed under the Barco name, as well as the registered trademarks Rocket, Kelly Perfect, Kelly Woodslasher, Woodslasher, and Light Duty.

Barco Industries, Inc.  
1020 Macarthur Road  
Reading, PA 19605  
Phone: (800) 234-8665  
Fax: (610) 374-6320

**Bear Creek Tool Company** specializes in hand-forged broadaxes and about 15 types of adzes. Their products have been used during a number of historical restoration projects. This is a small family operation owned by Charlie Wilkins.

Bear Creek Tool Company  
201 North Bear Creek Road  
Marshall, NC 28753  
Phone: (828) 649-2671

**Collins Axe Company** is part of the Mann Edge Tool Company. The Collins name has been associated with axes since 1826. The company offers a broad line of axes and replacement handles. Mann Edge Tool Company supplies ax heads to other manufacturers to market under different labels. Collins offers professional quality, 100% USA-made striking tools.



## Buying an Ax



Collins Axe Company  
Water & Dorcas Streets  
P.O. Box 351  
Lewistown, PA 17044  
Phone: (800) 248-8303 or (717) 248-9628  
Fax: (717) 248-4846

**Cooper Tools** is a conglomerate that manufactures hammers, axes, and chisels under the well-known Plumb trademark. Cooper Tools also owns the Nicholson, Lufkin, and Crescent trademarks, among many others.

Cooper Tools  
3535 Glenwood Avenue  
P.O. Box 30110  
Raleigh, NC 27622  
Phone: (919) 781-7200  
Fax: (919) 783-2116  
E-mail: cooperinfo@coopertools.com

**Council Tool Company** was founded in 1886 by John Pickett Council who developed tools for the turpentine harvesting industry. Today Council products include a full line of quality axes and other tools.

Council Tool Company  
345 Pecan Lane  
P.O. Box 165  
Lake Waccamaw, NC 28450-0165  
Phone: (919) 646-3011  
Fax: (910) 646-4414

**Estwing Manufacturing Company** offers a full line of axes, hatchets, and wood splitting tools. Most of these tools offer tubular or solid steel handles.

Estwing Manufacturing Company, Inc.  
2647 8th Street  
Rockford, IL 61109-1120  
Phone: (815) 397-9558  
Fax: (815) 397-8665  
E-mail: sales@estwing.com

**Gränsfors Bruks AB** is a Swedish company established in 1902. The company offers a full line of hand-forged traditional and specialty axes and hatchets, each stamped with the initials of the craftsman who forged it.

A sister company, Gränsfors Bruks, Inc., is located in Summerville, South Carolina. It imports and markets Gränsfors Bruks axes and spring steel wrecking bars, in addition to other products.

World Wide Web: <http://www.gransfors.com>

Gränsfors Bruks AB  
820 70 Bergsjö  
SWEDEN  
Phone: +46 (0) 6527-1090  
Fax: +46 (0) 6521-4002  
E-mail: axes@gransfors.com

Gränsfors Bruks, Inc.  
821 West 5th North Street  
P.O. Box 818  
Summerville SC 29484  
Phone: (800) 433-2863 or (843) 875-0240  
Fax: (843) 821-2285  
E-mail: info@gransfors.com

**O.P. Link Handle Company** is the largest manufacturer of hickory striking tool handles and farming tool handles in the United States. The Link family of handle makers operates factories in Salem, IN; Sequatchie, TN; Crossville, TN; and Hope, AR. The company can create almost any ax handle from the patterns shown in its catalog and from its inventory of less-popular handle patterns.

O.P. Link Handle Company  
403 S. Main Street  
Salem, IN 47167-1323  
Phone: (800) 992-9171 or (812) 883-2981  
Fax: (812) 883-1672

**Peavey Manufacturing Company** was founded in 1857 by Joseph Peavey, who developed the original "Peavey." Peavey does not manufacture axes, but it does make a host of log-moving and log-working tools and handles, including cant hooks, draw shaves, and its namesake tool, the Peavey.

World Wide Web: <http://www.peaveymfg.com>  
E-mail: order@peaveymfg.com

**Peavey Manufacturing Company**  
 Route 9  
 P.O. Box 129  
 Eddington, ME 04428  
 Phone: (888) 244-0955 or (207) 843-7861  
 Fax: (207) 843-5005

**Snow & Nealley**, Bangor, ME, is a family-owned and operated business that has been producing high-quality axes and woodworking tools since 1864.

World Wide Web: <http://www.sntools.com>

**Snow and Nealley, Inc.**  
 P.O. Box 876  
 Bangor, ME 04402-0876  
 Phone: (800) 790-8363  
 Fax: (207) 941-0857  
 E-mail: [sntools@mint.net](mailto:sntools@mint.net)

**Sandvik Saws and Tools Company** has developed from a provincial Swedish steelworks into an international, materials engineering conglomerate. Milford, Bahco, Belzer, and Lindström are some of the brands now incorporated under the Sandvik Saws and Tools division. The company manufactures high-quality sharpening tools, saws, and forestry tools.

World Wide Web: <http://www.sandvik.com>

**Sandvik Saws & Tools Company**  
 P.O. Box 2036  
 Scranton, PA 18501  
 Phone: (800) 828-9893  
 Fax: (800) 877-5687

**Tuatahi Axes and Saws** in New Zealand grinds and manufactures premium quality axes and saws for export to countries all over the world. Much of its inventory is custom made. Products available include competition racing axes, work axes, crosscut racing saws, knives, and grubbers. Bailey's is the distributor for Tuatahi products in the United States.

**Tuatahi Axes and Saws**  
 203 High Street  
 Masterton  
 New Zealand

Phone: (011) 646-377-3728  
 Fax: (011) 646-377-5343

**Bailey's**  
 World Wide Web: <http://www.bbaileys.com>

**Bailey's, Western Division**  
 P.O. Box 550  
 44650 Highway 101  
 Laytonville, CA 95454  
 Phone: (707) 984-6133  
 Fax: (707) 984-8115  
 E-mail: [baileys@bbaileys.com](mailto:baileys@bbaileys.com)

**Bailey's, Southeastern Division**  
 P.O. Box 9088  
 196 Edwards Drive  
 Jackson, TN 38314  
 Phone: (901) 422-1300  
 Fax: (901) 422-6118  
 E-mail: [baileys@bbaileys.com](mailto:baileys@bbaileys.com)

**Vaughan and Bushnell Mfg. Company** offers a line of striking tools, axes, hammers, and hatchets.

World Wide Web: <http://www.vaughanmfg.com>

**Vaughan and Bushnell Mfg. Company**  
 11414 Maple Avenue  
 Hebron, IL 60034  
 Phone: (603) 224-4669  
 Fax: (815) 648-4300  
 E-mail: [vaughanmfg@aol.com](mailto:vaughanmfg@aol.com)

## Distributors

**Ben Meadows Company** carries several brands of axes and hatchets, as well as a wide selection of equipment for natural resource managers.

World Wide Web: <http://www.benmeadows.com>

**Ben Meadows Company**  
 3589 Broad Street  
 Atlanta, GA 30341  
 Phone: (800) 241-6401  
 Fax: (800) 628-2068



## Buying an Ax

**The Country Workshops** has been providing instruction on Swedish carving techniques and other traditional woodworking skills since 1978. It also has an online store where axes, adzes, and other traditional woodworking tools can be purchased.

World Wide Web: <http://www.countryworkshops.org/toolhewing.html>

The Country Workshops  
90 Mill Creek Road  
Marshall, NC 28753-9321  
Phone: (704) 656-2280  
E-mail: [langsner@countryworkshop.org](mailto:langsner@countryworkshop.org)

**Forestry Suppliers, Inc.**, carries a large line of axes and hatchets from several manufacturers, as well as supplies for forestry, engineering, and environmental science.

World Wide Web: <http://www.forestry-suppliers.com>

Forestry Suppliers, Inc.  
P.O. Box 8397  
Jackson, MS 39284-9397  
Phone: (800) 647-5368  
Fax: (800) 543-4203

**Garrett Wade Company** offers a large selection of traditional woodworking products, including handtools, axes, and adzes.

World Wide Web: <http://www.garrettwade.com/home.html>

Garrett Wade Company  
161 Avenue of the Americas  
New York, NY 10013  
Phone: (800) 221-2942  
Fax: (800) 566-9525  
E-mail: [mail@garrettwade.com](mailto:mail@garrettwade.com)

**Lee Valley Tools** is another large supplier of traditional handtools, including axes, adzes, and log building tools. The company is based in Canada, but has an operation in the United States.

World Wide Web: <http://www.leevalley.com>

Lee Valley Tools, Ltd.  
P.O. Box 1780  
Ogdensburg, NY 13669-6780  
Phone: (800) 871-8158  
Fax: (800) 513-7885

**Lester C. Kenway Trail Services**, founded in 1994, features handtools by such companies as Snow & Nealley, Collins, Peavey, and Sandvick. It also specializes in rock-moving equipment.

Lester C. Kenway Trail Services  
15 Westwood Road  
Bangor, ME 04401  
Phone: (207) 947-2723  
Fax: (207) 945-6050  
E-mail: [trailer@ctel.net](mailto:trailer@ctel.net)

**Sticks & Stones Unlimited, Inc.**, distributes the machine-knife stone, Item No. SB-74. This 4-by 1½-inch oilstone has a groove cut into its circumference to help protect fingers from sharpened edges. This stone works well for sharpening axes as an alternative to the thinner, traditional round stone. The company distributes other stones and sharpening tools.

Sticks & Stones Unlimited, Inc.  
1800 East Northwest Parkway  
Southlake, TX 76092  
Phone: (800) 966-7574 or (817) 488-9500  
Fax: (817) 488-5397

**Woodcraft**, in business since 1928, is a good source for broadaxes, adzes, hatchets, and other woodworking tools.

World Wide Web: <http://www.woodcraft.com>

Woodcraft  
210 Wood County Industrial Park  
P.O. Box 1686  
Parkersburg, WV 26102-1686  
Phone: (800) 225-1153  
Fax: (304) 428-8271

## Organizations

Many organizations have been established for persons who collect or use old tools. The organizations typically publish newsletters and hold meetings to display, discuss, and trade tools. The two largest national tool collecting organizations in North America are the Early American Industries Association and the Mid-West Tool Collectors Association.

### **Early American Industries Association**

c/o Elton Hall  
167 Bakerville Road  
South Dartmouth, MA 02748

World Wide Web: <http://www.eaiainfo.org>

The purpose of the Early American Industries Association, Inc., founded in 1933, is to encourage the study and better understanding of early American industries in the home, in the shop, on the farm, and on the sea; also to discover, identify, classify, preserve, and exhibit obsolete tools, implements, and mechanical devices that were used in early America. The association also offers its members a great selection of books at reduced prices.

### **Mid-West Tool Collectors Association**

William R. Rigler, Treasurer  
RR 2, Box 152  
Wartrace, TN 37183

World Wide Web: <http://www.mwtca.org>

The Mid-West Tool Collectors Association is a nonprofit international organization dedicated to the study, preservation and understanding of the early tools, implements, and devices used by our ancestors in their homes, shops, on the farms and on the seas, and to a better perception of the industries and crafts in which these tools were used as well as the craftsmen who used them. M-WTCA was started by 16 Chicago-area tool collectors in 1968 and has grown to 3,900 members in all 50 states and 5 other countries.

Regional organizations (many more exist; these organizations are among the largest)

### **Pacific Northwest Tool Collectors (PNTC)**

Jean Racine, Treasurer  
12780 SW 231st Pl.  
Hillsboro, OR 97123

### **Potomac Antique Tools and Industries Association, Inc. (PATINA)**

Greg Wilinski, Sec./Treasurer  
7007 Hundsford Lane  
Springfield, VA 22153

### **Preserving Arts and Skills of the Trades (PAST) Tool Organization**

Allan Foster, Membership Director  
5200 Lawton Avenue  
Oakland, CA 94618



**B**uying an Ax



# S

## Selected References

---

- Andrews, Ralph W.** 1984. Timber. Exton, PA: Schiffer Publishing, Ltd.
- Andrews, Ralph W.** 1984. This was logging! Selected photographs of Darius Kinsey. ISBN: 0-88740-035-3. Exton, PA: Schiffer Publishing, Ltd. 157 p.
- Andrews, Ralph W.** Glory days of logging. Copyright Superior Publishing Co., MCMLVI, Seattle, WA. New York: Bonanza Books. 176 p.
- Berg, Elizabet,** ed. 1997. The axe book. ISBN: 91-970447-6-8. Sweden: Gränsfors Bruks AB. 36 p.
- Bohn, Dave.** 1986. Kinsey, photographer. ISBN: 0-87701-287-3. San Francisco: Chronicle Books. 319 p.
- Fickes, Clyde P.; Groben, W. Ellis.** 1945. Building with logs. Publ. No. 579. Washington, D.C.: U.S. Department Of Agriculture. 68 p.
- Foley, Vernard; Moyer, Richard H.** 1977. The American ax — was it better? Chronicle of the Early American Industries Association. XXX. June.
- Gamble, James D.** 1986. Broad axes. ISBN: 0-9617220-0-2. Los Altos, CA: Tanro Co.
- Goodman, W. L.** 1964. The history of woodworking tools. London: G. Bell and Sons. 208 p.
- Grismer, Jerome T.; Kendrick, Clyde H.** 1985. American embossed axes. Columbia, MO: General Printing Service. 177 p.
- Hallman, Richard.** 1988. Handtools for trail work. Gen. Tech. Rep. 8823-2601-MTDC. Missoula, MT: U.S. Department of Agriculture, Forest Service, Missoula Technology and Development Center. 54 p.
- Heavrin, Charles A.** 1998. The axe and man. Memphis, TN: Charles Heavrin. 182 p.
- Hodgkinson, Ralph.** 1965. Tools of the woodworker: axes, adzes and hatchets. 1965. History Tech. Leaflet 28. American Association for State and Local History. History News. 20 (5). May.
- Kijowski, Gene W.,** ed. 1990. Directory of American tool makers: colonial times to 1899. Early American Industries Association. 394 p.
- Klenman, Alan.** 1990. Axe makers of North America. Victoria, BC: Whistle Punk Books. 112 p.
- Klenman, Allen.** 1981. Axes made, found or sold in Canada. Victoria, BC: Idealetter Services. 44 p.
- Kauffman, Henry J.** 1994. American axes. ISBN: 1-883294-12-6. Elverson, PA: Olde Springfield Shoppe. 151 p.
- Mason, Bernard S.,** drawings by Frederic H. Kock. 1954. Woodsmanship. Library of Congress Card No. 54-5406. New York: A.S. Barnes and Co., Inc. 90 p.
- McLaren, Peter.** [1929]. Axe manual of Peter McLaren. Philadelphia, PA: Fayette R. Plumb, Inc. 84 p.
- Mercer, Henry C.** 1960. Ancient carpenters' tools. Doylestown, PA: Bucks County Historical Society.
- Mercer, Henry C.** 1967. The origin of log houses in the United States. Doylestown, PA: Bucks County Historical Society. 31 p.
- Phelps, Hermann.** 1982. The craft of log building. ISBN: 0-9691019-1-0. Ottawa, Ontario: Lee Valley Tools. 328 p.
- Salaman, R.A., rev. by Philip Walker.** 1990. Dictionary of woodworking tools, c.1700-1970. ISBN: 0-942391-51-9. Newtown, CT: Taunton Press. 546 p.
- Sellens, Alvin.** 1990. Dictionary of American hand tools. ISBN: 0-9612068-4-5. Augusta, KS: Alvin Sellens. 546 p.
- Simmons, Fred C.** 1951. Northeastern loggers' handbook. Agriculture Handbook No. 6. Washington, D.C.: U.S. Department of Agriculture.
- Sloane, Eric.** 1974. A museum of early American tools. ISBN: 345-24675-6-295. New York: Ballantine Books. 108 p.
- Sorden, L.G.; Vallier, Jacques.** 1986. Lumberjack. ISBN: 0-942802-12-8. North Word, Inc. 261 p.
- Williams, Richard L.** 1976. The loggers. Library of Congress Card No. 75-24792. New York: Time-Life Books. 240 p.



**S** Selected References





**Notes:**

**Notes:**

## **Library Card**

Weisgerber, Bernie; Vachowski, Brian, 1999. *An Ax to Grind: A Practical Ax Manual*. Technical Report, 9923-2823-MTDC. Missoula, MT: U.S. Department of Agriculture, Forest Service, Missoula Technology and Development Center. 60 p.

A practical and detailed handbook about axes and their historic and continuing usage. Describes types and patterns of axes and adzes, with many photos and illustrations. Shows how to hang (re-handle) and sharpen axes. Describes proper ax usage for tree felling, limbing, bucking, splitting, and hewing. Lists procurement sources and selected references.

**Keywords:** axes, adzes, hand tools, hewing, historic buildings, historic forestry practices, log cabin restoration, traditional Americana

### **Additional single copies of this document may be ordered from:**

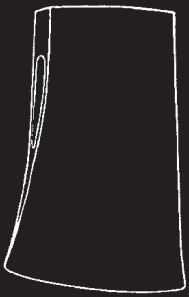
USDA Forest Service  
Missoula Technology and Development Center  
Building 1, Fort Missoula  
Missoula, MT 59804-7294  
Phone: (406) 329-3900  
Fax: (406) 329-3719  
IBM: pubs/wo,mtdc  
E-mail: pubs/wo\_mtdc@fs.fed.us

### **For additional technical information, contact Brian Vachowski at the address above.**

Phone: (406) 329-3935  
Fax: (406) 329-3719  
IBM: bvachowski/wo,mtdc  
E-mail: bvachowski/wo\_mtdc@fs.fed.us

### **An electronic copy of this document is available on the Forest Service's FS Web Intranet at:**

<http://fsweb.mtdc.wo.fs.fed.us>



**LONG ISLAND**  
2 ½ to 3 ½ lbs.



**NARROW WISCONSIN**  
3 to 5 lbs.



**NEW ENGLAND or IMPROVED WISCONSIN**  
2 ½ to 6 lbs.



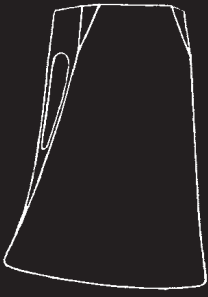
**YANKEE**  
3 to 8 lbs.



**DELAWARE or WIDE BIT DAYTON**  
3 to 5 lbs.



**DAYTON**  
3 to 8 lbs.



**RAFTING**  
5 lbs.



**HOOSIER**  
3 to 5 lbs.



**WEDGE**  
3 to 5 lbs.



**HALF WEDGE**  
3 to 5 lbs.



**CONNECTICUT**  
2 ½ to 5 lbs.



**MICHIGAN**  
3 to 8 lbs.



**ROCKAWAY**  
3 to 6 lbs.



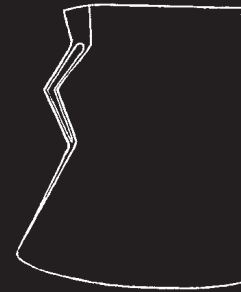
**NORTH CAROLINA**  
3 to 7 lbs.



**KENTUCKY**  
3 to 7 lbs.



**BALTIMORE KENTUCKY**  
3 to 7 lbs.



**JERSEY**  
2 ½ to 6 lbs.



**WEDGE**  
3 to 4 lbs.



**WISCONSIN**  
3 to 5 lbs.



**NARROW MICHIGAN**  
3 to 4 lbs.



**MICHIGAN**  
2 ½ to 7 lbs.



**WESTERN or PENNSYLVANIA**  
3 to 7 lbs.



**REVERSIBLE or HALF PEELING**  
3 to 6 lbs.



**FULL PEELING**  
3 to 5 lbs.



**REDWOOD or HUMBOLDT**  
3 to 5 lbs.



**YOUNG**  
3 to 5 lbs.



**SWAMPING**  
3 to 5 lbs.



**PUGET SOUND FALLING**  
3 to 5 lbs.